

SONY[®]

4-086-249-12(2)

GRAND WEGA

LCD Projection TV
HD-Monitor
Operating Instructions

KF-60DX100

DRC
Digital Reality Creation

 **CineMotion**
reverse 3-2 pull down technology

WARNING

To prevent fire or shock hazard, do not expose the LCD Projection TV to rain or moisture.

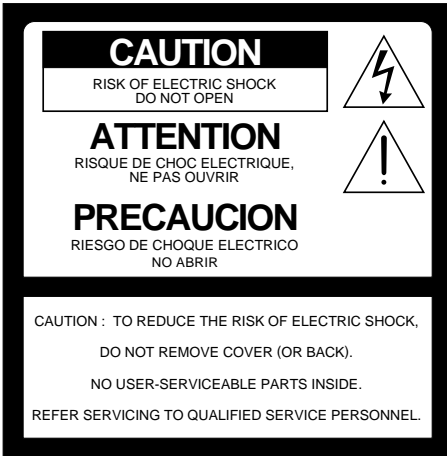

This symbol is intended to alert the user to the presence of uninsulated “dangerous voltage” within the product’s enclosure that may be of sufficient magnitude to constitute a risk of electric shock to persons.



This symbol is intended to alert the user to the presence of important operating and maintenance (servicing) instructions in the literature accompanying the appliance.

CAUTION

To prevent electric shock, do not use this polarized AC plug with an extension cord, receptacle or other outlet unless the blades can be fully inserted to prevent blade exposure.

Note on Caption Vision

This television receiver provides display of television closed captioning in accordance with §15.119 of the FCC rules.

Note to CATV system installer

This reminder is provided to call the CATV system installer’s attention to Article 820-40 of the NEC that provides guidelines for proper grounding and, in particular, specifies that the cable ground shall be connected to the grounding system of the building, as close to the point of cable entry as practical.

Use of this television receiver for other than private viewing of programs broadcast on UHF, VHF, transmitted by cable companies or satellite for the use of the general public may require authorization from the broadcaster/cable company and/or program owner.

NOTIFICATION

This equipment has been tested and found to comply with the limits for a Class B digital device pursuant to Part 15 of the FCC Rules. These limits are designed to provide reasonable protection against harmful interference in a residential installation. This equipment generates, uses, and can radiate radio frequency energy and, if not installed and used in accordance with the instructions, may cause harmful interference with radio communications. However, there is no guarantee that interference will not occur in a particular installation. If this equipment does cause harmful interference to radio or television reception, which can be determined by turning the equipment off and on, the user is encouraged to try to correct the interference by one or more of the following measures:

- Reorient or relocate the receiving antennas.
- Increase the separation between the equipment and receiver.
- Connect the equipment into an outlet on a circuit different from that to which the receiver is connected.
- Consult the dealer or an experienced radio/TV technician for help.

You are cautioned that any changes or modifications not expressly approved in this manual could void your warranty and your authority to operate this equipment.

This document is for the remote control RM-Y910.
MODEL: KF-60DX100

Please keep this notice with the instruction manual.

Safety

- ❑ Operate the LCD Projection TV only on 120 V AC.
- ❑ The plug is designed, for safety purposes, to fit into the wall outlet only one way. If you are unable to insert the plug fully into the outlet, contact your dealer.
- ❑ If any liquid or solid object should fall inside the cabinet, unplug the LCD Projection TV immediately and have it checked by qualified service personnel before operating it further.
- ❑ If you will not be using the LCD Projection TV for several days, disconnect the power by pulling the plug itself. Never pull on the cord.
For details concerning safety precautions, see “Important Safeguards” on page 4.

Installing

- ❑ To prevent internal heat buildup, do not block the ventilation openings.
- ❑ Do not install the LCD Projection TV in a hot or humid place, or in a place subject to excessive dust or mechanical vibration.
- ❑ Avoid operating the LCD Projection TV at temperature below 41°F (5°C).
- ❑ If the LCD Projection TV is transported directly from a cold to a warm location, or if the room temperature changes suddenly, the picture may be blurred or show poor color. In this case, please wait a few hours to let the moisture evaporate before turning on the LCD Projection TV.
- ❑ To obtain the best picture, do not expose the screen to direct illumination or direct sunlight. It is recommended to use spot lighting directed down from the ceiling or to cover the windows that face the screen with opaque drapery. It is desirable to install the LCD Projection TV in a room where the floor and walls are not of a reflective material.

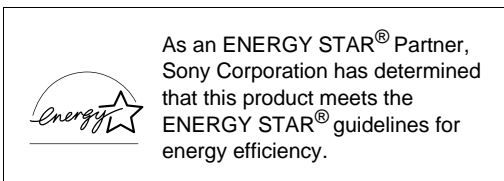

ENERGY STAR® is a U.S. registered mark.

TruSurround and the (●) symbol are trademarks of SRS Labs, Inc.

TruSurround technology is incorporated under license from SRS Labs, Inc.

Manufactured under license from Dolby Laboratories. Dolby and the double-D symbol are trademarks of Dolby Laboratories.

Confidential unpublished works. © 1992-1997 Dolby Laboratories. All rights reserved.

CineMotion is trademark of Sony.

BBE and BBE Symbol are trademarks of BBE Sound, Inc. and are licensed by BBE Sound, Inc. under U.S. Patent No. 4,638,258 and 4,482,866.

ATTENTION

Pour prévenir les chocs électriques, ne pas utiliser cette fiche polarisée avec un prolongateur, une prise de courant ou une autre sortie de courant, sauf si les lames peuvent tre insérées à fond sans en laisser aucune partie à découvert.

Owner's Record

The model and serial numbers are located at the rear of the LCD Projection TV, below the Sony logo, on the sticker, and also on the TV box (white label). Record these numbers in the spaces provided below. Refer to them whenever you call upon your Sony dealer regarding this product.

Model No. _____

Serial No. _____

Important Safety Instruction

- 1) Read these instructions.
- 2) Keep these instructions.
- 3) Heed all warnings.
- 4) Following all instructions.
- 5) Do not use this apparatus near water.
- 6) Clean only with dry cloth.
- 7) Do not block any ventilation openings. Install in accordance with the manufacturer's instructions.
- 8) Do not install near any heat sources such as radiators, heat registers, stoves, or other apparatus (including amplifiers) that produce heat.
- 9) Do not defeat the safety purpose of the polarized or grounding-type plug. A polarized plug has two blades with one wider than the other. A grounding type plug has two blades and a third grounding prong. The wide blade or the third prong are provided for your safety. If the provided plug does not fit into your outlet, consult an electrician for replacement of the obsolete outlet.
- 10) Protect the power cord from being walked on or pinched particularly at plugs, convenience receptacles, and the point where they exit from the apparatus.
- 11) Only use attachments/accessories specified by the manufacturer.
- 12) Use only with the cart stand, tripod, bracket, or table specified by the manufacturer, or sold with the apparatus. When a cart is used, use caution when moving the cart/apparatus combination to avoid injury from tip-over.
- 13) Unplug this apparatus during lightning storms or when unused for long periods of time.
- 14) Refer all servicing to qualified service personnel. Servicing is required when the apparatus has been damaged in any way, such as power-supply cord or plug is damaged, liquid has been spilled or objects have fallen into the apparatus, the apparatus has been exposed to rain or moisture, does not operate normally, or has been dropped.
- 15) Apparatus shall not be exposed to dripping or splashing and no objects filled with liquids, such as vases, shall be placed on the apparatus.

Important Safeguards

For your protection, please read these instructions completely, and keep this manual for future reference.

Carefully observe and comply with all warnings, cautions and instructions placed on the set or described in the operating instructions or service manual.

WARNING

To guard against injury, the following basic safety precautions should be observed in the installation, use and servicing of the set.

Use

Power Sources

This set should be operated only from the type of power source indicated on the serial/model plate. If you are not sure of the type of electrical power supplied to your home, consult your dealer or local power company. For those sets designed to operate from battery power, refer to the operating instructions.



Grounding or Polarization

This set is equipped with a polarized AC power cord plug (a plug having one blade wider than the other), or with a three-wire grounding type plug (a plug having a third pin for grounding). Follow the instructions below:

For the set with a polarized AC power cord plug

This plug will fit into the power outlet only one way. This is a safety feature. If you are unable to insert the plug fully into the outlet, try reversing the plug. If the plug still fails to fit, contact your electrician to have a suitable outlet installed. Do not defeat the safety purpose of the polarized plug by forcing it in.

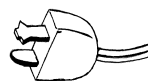

Alternate Warning for the set with a three-wire grounding type AC plug

This plug will only fit into a grounding-type power outlet. This is a safety feature. If you are unable to insert the plug into the outlet, contact your electrician to have a suitable outlet installed. Do not defeat the safety purpose of the grounding plug.

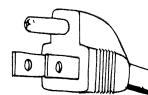

Overloading

Do not overload wall outlets, extension cords or convenience receptacles beyond their capacity, since this can result in fire or electric shock.

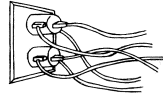

Always turn the set off when it is not being used. When the set is left unattended and unused for long periods of time, unplug it from the wall outlet as a precaution against the possibility of an internal malfunction that could create a fire hazard.



If a snapping or popping sound from a TV set is continuous or frequent while the TV is operating, unplug the TV and consult your dealer or service technician. It is normal for some TV sets to make occasional snapping or popping sounds, particularly when being turned on or off.

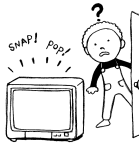

Object and Liquid Entry

Never push objects of any kind into the set through the cabinet slots as they may touch dangerous voltage points or short out parts that could result in a fire or electric shock. Never spill liquid of any kind on the set.



Attachments

Do not use attachments not recommended by the manufacturer, as they may cause hazards.

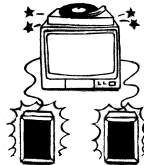

Cleaning

Clean the cabinet of the LCD Projection TV with a dry soft cloth. To remove dust from the screen, wipe it gently with a soft cloth. Stubborn stains may be removed with a cloth slightly dampened with solution of mild soap and warm water. Never use strong solvents such as thinner or benzene for cleaning.



If the picture becomes dark after using the LCD Projection TV for a long period of time, it may be necessary to clean the inside of the LCD Projection TV. Consult qualified service personnel.

Installation

Water and Moisture

Do not use power-line operated sets near water — for example, near a bathtub, washbowl, kitchen sink, or laundry tub, in a wet basement, or near a swimming pool, etc.



Accessories

Do not place the set on an unstable cart, stand, table or shelf. The set may fall, causing serious injury to a child or an adult and serious damage to the set. Use only a cart or stand recommended by the manufacturer for the specific model of LCD Projection TV. An appliance and cart combination should be moved with care. Quick stops, excessive force, and uneven surfaces may cause the appliance and cart combination to overturn.



Ventilation

The slots and openings in the cabinet and in the back or bottom are provided for necessary ventilation. To ensure reliable operation of the set, and to protect it from overheating, these slots and openings must never be blocked or covered.

- Never cover the slots and openings with a cloth or other materials.
- Never block the slots and openings by placing the set on a bed, sofa, rug or other similar surface.
- Never place the set in a confined space, such as a bookcase or built-in cabinet, unless proper ventilation is provided.
- Do not place the set near or over a radiator or heat register, or where it is exposed to direct sunlight.



Power-Cord Protection

Do not allow anything to rest on or roll over the power cord, and do not place the set where the power cord is subject to wear or abuse.



Antennas

Outdoor Antenna Grounding

If an outdoor antenna is installed, follow the precautions below. An outdoor antenna system should not be located in the vicinity of overhead power lines or other electric light or power circuits, or where it can come in contact with such power lines or circuits.

WHEN INSTALLING AN OUTDOOR ANTENNA SYSTEM, EXTREME CARE SHOULD BE TAKEN TO KEEP FROM CONTACTING SUCH POWER LINES OR CIRCUITS AS CONTACT WITH THEM IS ALMOST INVARIABLY FATAL.

Be sure the antenna system is grounded so as to provide some protection against voltage surges and built-up static charges.

Section 810 of the National Electrical Code (NEC) in USA and Section 54 of the Canadian Electrical Code in Canada provides information with respect to proper grounding of the mast and supporting structure, grounding of the lead-in wire to an antenna discharge unit, size of grounding conductors, location of antenna discharge unit, connection to grounding electrodes, and requirements for the grounding electrode.

Antenna Grounding According to the NEC

Refer to section 54-300 of Canadian Electrical Code for Antenna Grounding.

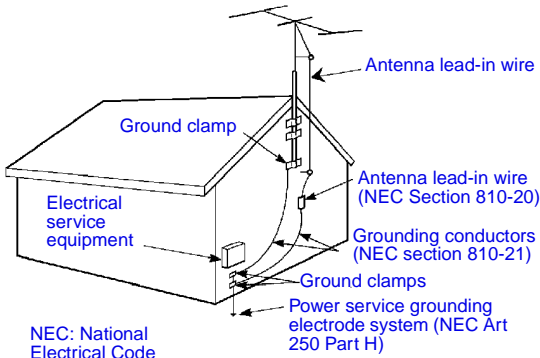

Lightning

For added protection for this television receiver during a lightning storm, or when it is left unattended and unused for long periods of time, unplug it from the wall outlet and disconnect the antenna. This will prevent damage to the receiver due to lightning and power-line surges.

Service

Damage Requiring Service

Unplug the set from the wall outlet and refer servicing to qualified service personnel under the following conditions:

- When the power cord or plug is damaged or frayed.
- If liquid has been spilled into the set.
- If the set has been exposed to rain or water.
- If the set has been subject to excessive shock by being dropped, or the cabinet has been damaged.
- If the set does not operate normally when following the operating instructions. Adjust only those controls that are specified in the operating instructions. Improper adjustment of other controls may result in damage and will often require extensive work by a qualified technician to restore the set to normal operation.
- When the set exhibits a distinct change in performance, it indicates a need for service.

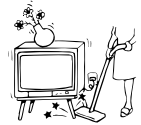

Servicing

Do not attempt to service the set by yourself since opening the cabinet may expose you to dangerous voltage or other hazards. Refer all servicing to qualified service personnel.



Replacement Parts

When replacement parts are required, be sure the service technician certifies in writing that he has used replacement parts specified by the manufacturer that have the same characteristics as the original parts.

Unauthorized substitutions may result in fire, electric shock or other hazards.

Safety Check

Upon completion of any service or repairs to the set, ask the service technician to perform routine safety checks (as specified by the manufacturer) to determine that the set is in safe operating condition, and to so certify. When the set reaches the end of its useful life, improper disposal could result in a picture tube implosion. Ask a qualified service technician to dispose of the set.



For Safety

Be careful when moving the LCD Projection TV

When you place the LCD Projection TV in position, be careful not to drop it on your foot or fingers.

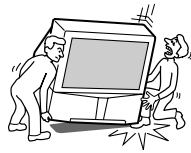

Watch your footing while installing the LCD Projection TV.

Carry the LCD Projection TV in the specified manner

If you carry the LCD Projection TV in a manner other than the specified manner and without the specified number of persons, it may drop and a serious injury may be caused. Be sure to follow the instructions mentioned below.



- ❑ Carry the LCD Projection TV with the specified number of persons (see page 18).
- ❑ Do not carry the LCD Projection TV holding the speaker grill.
- ❑ Hold the LCD Projection TV tightly when carrying it.

About the LCD Projection TV

Although the LCD projection TV is made with high-precision technology, black dots may appear or bright points of light (red, blue, or green) may appear constantly on the LCD screen. This is a structural property of the LCD panel and is not a malfunction.

Installation

- ❑ If direct sunlight or other strong illumination shines on the screen, part of the screen appears white due to reflections from behind the screen. This is a structural property of the LCD Projection TV. Do not expose the screen to direct illumination or direct sunlight.
- ❑ The picture quality may be affected by your viewing position. If you view the TV close to you, you may suffer from eye fatigue. For the best picture quality, install your LCD projection TV according to the operating instructions. Sit at least 2.2 m (approx. 7 ft.) away from your LCD projection TV, and within 60° of the vertical viewing area, and 130° of the horizontal viewing area.
- ❑ When installing your LCD Projection TV against a wall, keep it at least 10 cm (4 inches) from the wall.

Projection lamp

- ❑ Your LCD projection TV uses a projection lamp as its light source. When the projection lamp wears out after using the LCD projection TV for a long period of time, the screen image becomes dark, or no image will appear on the display. If the lamp replacement indicator of the front panel blinks in red, replace the lamp with a new one (not supplied). In some cases, the lamp bursts inside the lamp unit noisily, but the lamp unit is securely designed so that the pieces of broken glass remain inside the lamp unit. (See “Replacing the Lamp” on page 13.)

Cooling fan

- ❑ This LCD projection TV uses a cooling fan to prevent the internal temperature from heating up. You might hear the noise from the cooling fan, depending on the place you install the LCD projection TV.

Contents

Introducing the Sony LCD Projection TV

Presenting the Sony LCD Projection TV	9
Using This Manual.....	10
Enjoying Your LCD Projection TV	11
Replacing the Lamp	13

Installing and Connecting the LCD Projection TV

Contents	17
Inserting Batteries into the Remote Control	17
Carrying Your LCD Projection TV	18
To Prevent the LCD Projection TV from Falling Down	19
When Installing Your LCD Projection TV Against a Wall	19
Recommended Viewing Area	20
Connector Types	21
LCD Projection TV Controls and Connectors	22
Basic Connections (Connecting Cable TV or Antenna).....	25
Connecting a VCR and Cable	29
Connecting a VCR and Cable Box	30
Connecting Two VCRs for Tape Editing	32
Connecting a Satellite Receiver	33
Connecting a Satellite Receiver with a VCR	34
Connecting an Audio Receiver	35
Connecting a DVD Player with Component Video Connectors.....	36
Connecting a DVD Player with A/V Connectors	37
Connecting a Digital TV Receiver.....	38
Connecting a Camcorder	39
Connecting an AV Receiver	40
Using the CONTROL S Feature	41
Setting Up the LCD projection TV Automatically.....	42

Using the Features

Using the Remote Control	43
Watching the TV	46
Watching the Digital TV	48
Using Favorite Channels.....	49
Using Twin View™.....	50
Using the Freeze Function	53
Using Scrolling Channel Index.....	54
Using Wide Screen Mode	56

Using the Menu

Overview.....	57
Using the Video Menu.....	58
Using the Audio Menu.....	60
Using the Channel Menu	62
Using the Wide Menu	64
Using the Timer Menu.....	66
Using the Setup Menu	67

Other Information

Programming the Remote Control.....	77
Operating Other Components with Your LCD Projection TV Remote Control.....	80
Troubleshooting.....	82
What Flashing of the Indicators on the Front of the Monitor Means.....	85
Specifications.....	86

Introducing the Sony LCD Projection TV

Presenting the Sony LCD Projection TV

Thank you for purchasing the Sony LCD Projection TV.
This manual is for model KF-60DX100.

Features

Some of the features that you will enjoy with your new LCD projection TV include:

- ❑ **HD-Monitor:** Enables you to receive the 1080i, 720p*, 480p and 480i digital TV format signals.
By using the HD/DVD IN jacks, you can connect a DTV (digital television) receiver to view DTV programs.
- ❑ **DRC™:** Unlike conventional line doublers, the DRC (Digital Reality Creation) feature converts frames reproduced every 1/60th of a second in real time, minimizing the blur or ghost of the motion images (for NTSC signals only).
- ❑ **CineMotion™:** Using the reverse 3-2 pull down technology, the CineMotion feature allows you to obtain a smooth picture movement when playing back movies or other video sources on film.
- ❑ **Twin View™:** Using Multi-Image Driver (MID-X), Twin View allows you to watch two programs side by side with the ability to zoom in on one picture and listen to the program in the selected window. You can watch pictures from two different sources (1080i, 720p*, 480p or 480i) simultaneously.
- ❑ **Parental Control:** V-Chip technology allows parents to block unsuitable programming for younger viewers.
- ❑ **Component Video Inputs:** Offers the best video quality for DVD (480p, 480i) and Digital Set-top box (1080i, 720p*, 480p, 480i) connections.
- ❑ **S-VIDEO Inputs:** Provides a high-quality image for connected equipment.
- ❑ **Favorite Channel Preview:** Preview up to eight favorite channels without leaving the current channel.
- ❑ **Scrolling Channel Index:** Allows you to view and choose channels from scrolling pictures without leaving the current channel.

* This LCD projection TV is not capable of displaying a native 720p format signal. Therefore, when a native 720p format signal is received, it is converted into a 480p format signal.

(Continued)

- ❑ **Wide Screen Mode:** Allows you to watch 4:3 normal broadcasts in wide screen mode (16:9 aspect ratio).
- ❑ **Auto Wide:** Allows you to select the wide screen mode automatically.

Using This Manual

We recommend that you carefully review the contents of the following three sections in the order shown to ensure that you fully understand the operation of your new LCD projection TV.

1 Installing and Connecting the LCD Projection TV

This section guides you through your initial setup. It shows you how to install your LCD projection TV, to connect your new components and to connect the antenna and cable.

2 Using the Features

This section shows you how to begin using your new LCD projection TV. It also shows you how to use your remote control functions.

3 Using the menus

This section teaches you how to access on-screen menus and adjust your LCD projection TV settings.

Instructions in this manual are written for the remote control. Similar controls are also found on the LCD projection TV console.

Enjoying Your LCD Projection TV

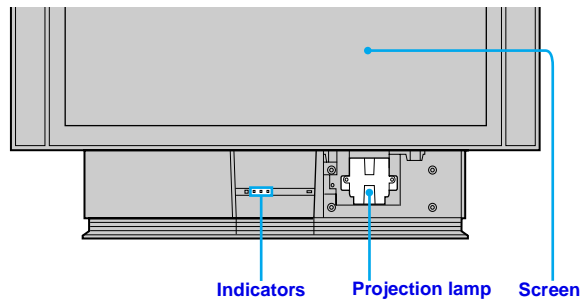

Indicators

The indicators show the current status of your LCD projection TV. If the LAMP indicator flashes, see “What Flashing of the Indicators on the Front of the Monitor Means” on page 85.

Screen

To minimize screen reflection, its surface has a special coating. Read the instructions “Use of the Cleaning Cloth” on page 12 carefully before cleaning.

Inappropriate cleaning methods could damage the finishing.

Projection lamp

Your LCD projection TV uses a projection lamp as its light source. Note the following:

- ❑ After turning on your LCD projection TV, it may take a while before the normal screen appears (1 minute or less).
 - ❑ When the projection lamp wears out, the screen image becomes dark. Replace the lamp with a new Sony XL-2000U replacement lamp (not supplied).
- 👉 Be sure to attach the lamp cover securely; otherwise, your LCD projection TV will not turn on. For details on lamp replacement, see “Replacing the Lamp” on page 13.
 - 👉 The light emitted from the lamp is quite bright when your LCD projection TV is in use. To avoid eye discomfort or injury, do not look into the housing when the power is on.

**Notes on the LCD
Projection TV**

To enjoy clear pictures

- ❑ Be sure not to allow sunlight or light from a lamp to shine directly onto the screen.
- ❑ The screen surface is easily scratched. Do not rub, touch, or tap it with a sharp or abrasive object (see “Use of the Cleaning Cloth” below).

On moisture condensation

- ❑ If your LCD projection TV is transported directly from a cold to a warm location, is placed in a humid room, or if the room temperature changes suddenly, the picture may be blurred or show poor color. This is because moisture has condensed on the lenses inside. If this happens, leave the power on and let the moisture evaporate before using your LCD projection TV.

When the LCD projection TV will not be used for a long period of time



- ❑ Turn off the main power of your LCD projection TV before going to sleep or going out.

When turning off the power

- ❑ Be sure to turn off the power switch on the main unit or on the remote control. After turning off the power, the fan will continue to blow for about two minutes. Be sure to wait for several minutes after turning the power off when unplugging from the outlet or switching the breaker off.

**Use of the Cleaning
Cloth**

To remove dust from the front of the screen, wipe with the supplied Cleaning Cloth.

-  Do not use any type of abrasive pad, alkaline cleaner, scouring powder, or solvent such as alcohol or benzene. Otherwise, this type of contact may result in a damaged screen.
-  To clean the screen, please use the supplied Cleaning Cloth lightly moistened with water diluted mild detergent solution.
-  The supplied Cleaning Cloth is washable with warm water and a mild detergent solution, and can be used repeatedly.

Replacing the Lamp

The projection lamp has a limited life.

If the screen becomes dark, the color looks unusual, or the LAMP indicator on the front of the LCD projection TV flashes, it is time to replace the lamp with a new one (not supplied).



WARNING

Electric appliances can cause fire or high temperature, resulting in injury or death. Be sure to follow the instructions below.

- ❑ Use a Sony XL-2000U replacement lamp (not supplied) for replacement. Failure to do so may damage the LCD projection TV.
- ❑ Do not remove the lamp for any purpose other than replacement. Failure to do so may cause fire or a skin burn.
- ❑ Before replacing the lamp, turn the power off on the main unit, then several minutes later, unplug the power cord. (The cooling fan will continue to blow for about two minutes after turning the power off.)
- ❑ Before replacing the lamp, let it cool down completely, as the surface of the lamp remains extremely hot for at least 30 minutes after the power has been turned off.
- ❑ Do not leave the removed lamp near flammable materials or within the reach of children.
- ❑ Do not pour water onto the removed lamp, or put any object inside the lamp. Doing so may cause the lamp to burst.
- ❑ Do not put flammable materials and metal objects inside the lamp receptacle of the LCD projection TV after removing the lamp. Doing so may cause fire or electrical shock. Also, be sure not to touch the receptacle, because it may cause a skin burn.
- ❑ Mount the new lamp securely, otherwise the screen may become dark, or it may cause a fire.

Collecting the used lamp

For environmental conservation, Sony collects the used lamps. Please put the used lamp in the lamp box and give it to your Sony dealer where you bought the lamp.



Do not touch the front glass of a new lamp or the glass of the lamp receptacle. This may reduce picture quality or lamp life.

(Continued)

- 1 Turn off the power switch on the LCD projection TV and after several minutes, unplug the power cord.
(The cooling fan will continue to blow for about two minutes after turning the power off.)

 Do not touch the front glass of a new lamp or the glass of the lamp receptacle. This may reduce picture quality or lamp life.

- 2 Unplug the power cord after turning off the main power. Wait at least 30 minutes to allow the lamp to cool down before replacing it.
Take the new lamp out of the box.
- 3 Remove the front panel.

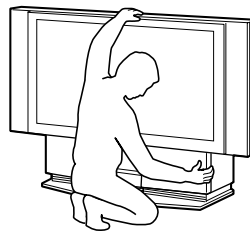

Hold the LCD projection TV firmly so that it does not move.

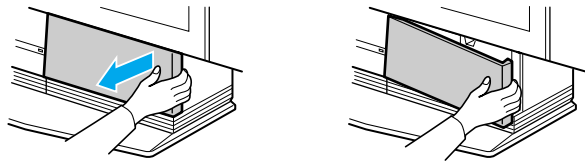

Grasping the right end of the front panel with your fingers, pull the panel towards you.

- 4 Loosen the screw with a coin or similar object to remove the lamp cover.

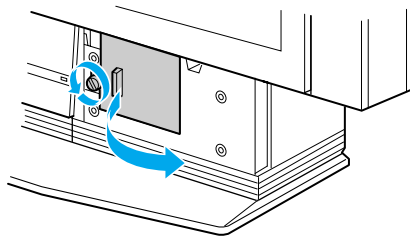

- 5 Loosen the two screws that secure the lamp, then pull out the lamp. The lamp is very hot immediately after use. Never touch the front glass of the lamp or the surrounding parts.

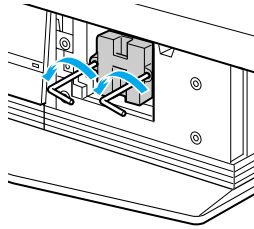

Loosen the two screws with the hex key supplied with the lamp.

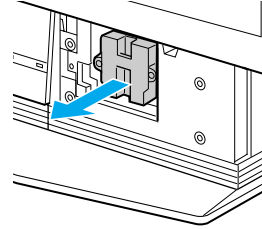

Hold the handle and pull straight out.

After it has cooled, place the removed lamp into the empty box of the replacement lamp. Never put the removed lamp into a plastic bag.

- 6 Mount the new lamp. Be sure to attach the new lamp securely.

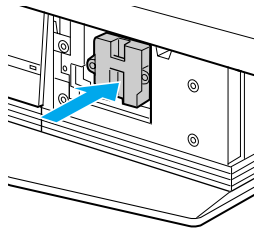

Mount the new lamp securely into the lamp receptacle.

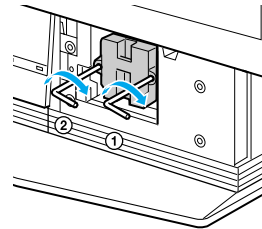

Tighten the two screws securely in the order of ① to ②, as shown in the illustration using the supplied hex key.

- 7 Mount the lamp cover and tighten the screw. Make sure that the lamp cover is mounted securely, otherwise the power will not turn on.

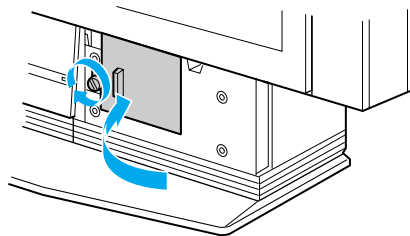

Match the projection of the right side of the lamp cover with the hole of the unit, and replace the lamp cover as it was.

If the lamp cover is not mounted securely, the self-diagnostic function works and the TIMER/STAND BY indicator flashes for three times (See page 85).

(Continued)

- 8 Mount the front panel in the order of ① to ②, as shown in the illustration.



- ⚠ Consult your Sony dealer for a Sony XL-2000U replacement lamp.
- ⚠ Take great care when replacing the lamp or plugging in/unplugging the connecting cords. If you handle them roughly, the LCD projection TV may fall or be moved, and the TV stand or floor surfaces may be scratched.

Installing and Connecting the LCD Projection TV



Contents

The box contains your new LCD projection TV, a remote control and two AA batteries. No peripheral cables are included. If you intend to add additional equipment to your LCD projection TV, please check the hookup instructions for your desired setup before you begin. You may need to purchase cables and/or splitters to complete the hookup properly.

Inserting Batteries into the Remote Control

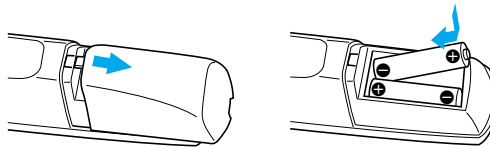
Insert two size AA batteries (supplied) by matching the + and – on the batteries to the diagram inside the battery compartment.



-  Remove the batteries to avoid damage from possible battery leakage whenever you anticipate that the remote control will not be used for an extended period.
-  Handle the remote control with care. Avoid dropping it, getting it wet, or placing it in direct sunlight, near a heater, or where the humidity is high.
-  Your remote control can be programmed to operate most video equipment. (See "Programming the Remote Control" on page 77.)

Carrying Your LCD Projection TV

Carrying the LCD projection TV requires at least two people. Do not grasp the pedestal or the front panel of the LCD projection TV, otherwise these parts might break off.

When moving the LCD projection TV, support the screen bottom with one hand while grasping the top part with the other hand, as shown in the illustration below.

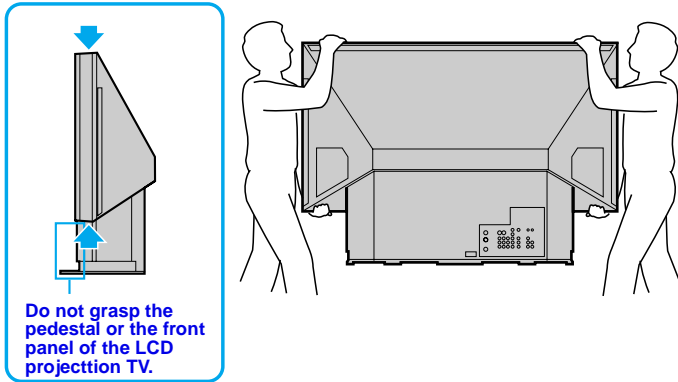

To Prevent the LCD Projection TV from Falling Down

Pay special attention to children around the LCD projection TV. If children should climb onto or push the LCD projection TV or its stand, it may fall down.

As a protective measure, secure the LCD projection TV as follows.

Using supplied brackets

- 1 Mount the two brackets with the screws (supplied) to the upper rear sides of the LCD projection TV (left and right sides).
- 2 Pass a strong cord or chain (not supplied) through each bracket and then secure it to a wall or a pillar, etc.

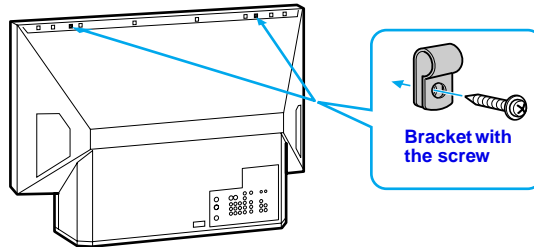

Using the LCD projection TV stand with support belts

- You can also use the LCD projection TV stand SU-60DX (not supplied) with support belts.

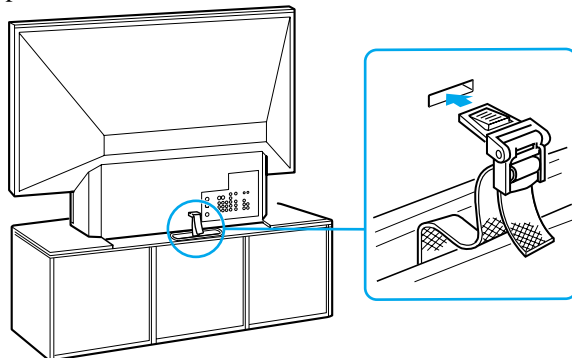

When Installing Your LCD Projection TV Against a Wall

Keep your LCD projection TV at least 10 cm (4 inches) from the wall.

Recommended Viewing Area

The picture quality may be affected by your viewing position.

For the best picture quality, install your LCD projection TV within the areas shown below.

Sit at least 2.2 m (approx. 7 ft.) away from your LCD projection TV, and within 60° of the vertical viewing area, and 130° of the horizontal viewing area.

Horizontal Viewing Area

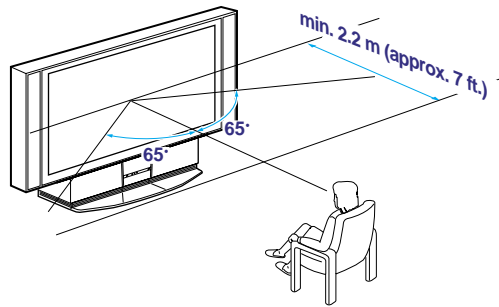

Vertical Viewing Area

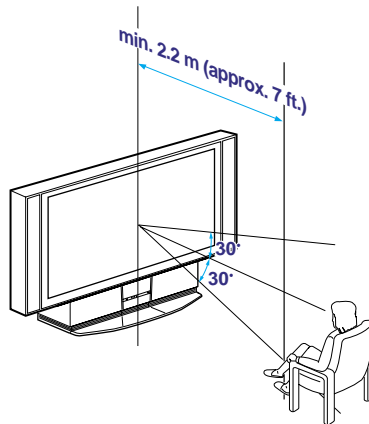

Connector Types

You may find it necessary to use some of the following connector types during set up.

Coaxial cable

Standard TV cable and antenna cable

Plug Type



Screw-on Type



S Video cable

High quality video cable for enhanced picture quality



Audio/Video cable



Video - Yellow

Audio (Left) - White

Audio (Right) - Red

Some DVD Players are equipped with the following three video connectors:

Y - Green

P_B (C_B, C_b or B-Y) - Blue

P_R (C_R, C_r or R-Y) - Red

CONTROL S cable

CONTROL S connections are exclusive to Sony products and allow greater control of all Sony equipment.



LCD Projection TV Controls and Connectors

Front Panel Menu Controls

The front panel menu controls allow access to the on-screen menus without the use of a remote control. Pressing MENU brings up the on-screen menus. The arrow buttons move the on-screen cursor in the menus and by pressing the Select button (+) selects the menu item.

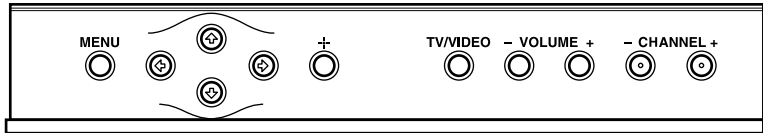

How to open and close the front panel

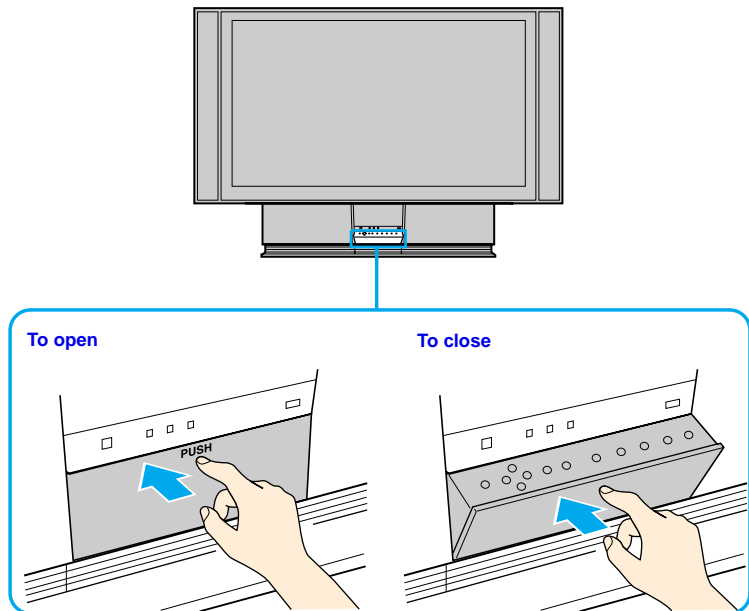

Connection	Description
1 AUX	Allows you to view local and cable channels if your cable provider does not feature local channels. You can switch between local and cable channels easily by pressing ANT on the remote control. Devices connected to the AUX input cannot be viewed in Twin View .
2 TO CONVERTER	This is a VHF/UHF OUT jack that lets you set up your LCD projection TV to switch between scrambled channels (through a cable box) and normal cable channels (CATV). Use this jack instead of a splitter to get better picture quality when switching between scrambled and unscrambled cable channels.
3 VHF/UHF	Connects to your VHF/UHF antenna or cable.
4 S VIDEO (Rear and side)	Connects to the S VIDEO OUT jack of your VCR or other S VIDEO -equipped video component. Provides better picture quality than the VHF/UHF jacks or the Video IN jack.
5 VIDEO (L/R)/AUDIO (Rear and side)	Connects to the audio and video OUT jacks on your VCR or other video component. A fourth video input (VIDEO 2) is located on the side panel of the LCD projection TV.
6 HD/DVD IN (1080i, 720p, 480p, 480i)	Connects to your DVD player's or Digital Set-top box's component video (Y, PB, PR) and audio (L/R) jacks.
7 TV OUT	Connects to an AV receiver for greater control of all audio and video equipment (see page 40). For detailed information about connection, refer to the operating manual supplied with the AV receiver .
8 AUDIO OUT (VAR/FIX) L (MONO)/R	Connects to the left and right audio inputs of your audio or video component.
9 CONTROL S IN/OUT	To control other Sony equipment with the LCD projection TV's remote control, connect the CONTROL S IN jack of the equipment to the CONTROL S OUT jack on the LCD projection TV with the CONTROL S cable. To control the LCD projection TV with a remote control for another Sony product, connect the CONTROL S OUT jack of the equipment to the CONTROL S IN jack on the LCD projection TV with the CONTROL S cable.

Basic Connections (Connecting Cable TV or Antenna)

Connecting Directly to Cable or an Antenna

The connection you choose depends on the cable found in your home. Newer homes are equipped with standard coaxial cable (see **A**); older homes probably have 300-ohm twin lead cable (see **B**); other homes may contain both (see **C**).

A VHF Only or VHF/UHF or Cable

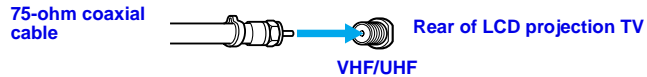

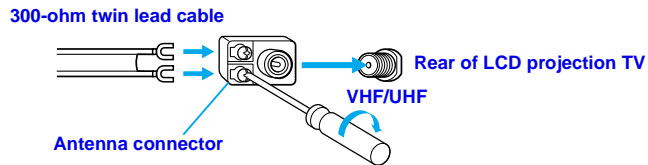

B VHF Only or UHF Only or VHF/UHF

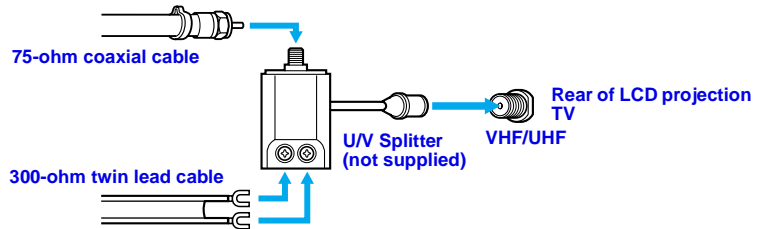

C VHF and UHF



 It is strongly recommended to connect the antenna using a 75-ohm coaxial cable to get optimum picture quality. A 300-ohm twin lead cable can be easily affected by radio noise and the like, resulting in signal deterioration. If you use a 300-ohm twin lead cable, keep it away as far as possible from the LCD projection TV.

 Do not use an indoor antenna because it is especially susceptible to radio noise.

Cable and Antenna

If your cable provider does not feature local channels, you may find this set up convenient.

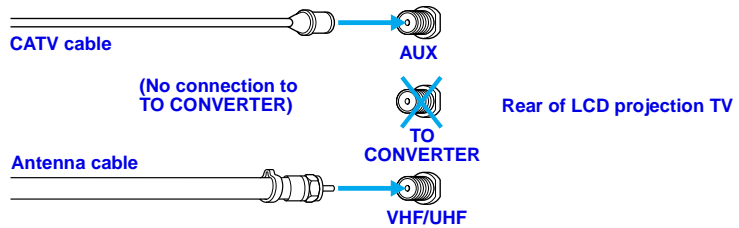

Select CABLE or antenna (ANT) mode by pressing ANT on the remote control.

 To receive channels with an antenna, you need to turn your Cable to OFF (see page 62) and perform the Auto Program function (see page 63).

Cable Box Connections

Cable Box and Cable

This is the preferred basic cable TV hookup to use if:

- Your cable TV company scrambles some channels, but not all of them (pay channels vs. regular cable channels) and you need to use a cable box, and
- You want to enjoy the Twin View feature.

With this setup you can:

- Use the LCD projection TV remote control to change channels using your cable box when the signal is scrambled.
- Use the LCD projection TV remote control to change channels using your LCD projection TV when the signal is not scrambled. (Your LCD projection TV's tuner provides a better signal than the cable box.)
- Use the Twin View feature. (When all channels are routed through your cable box, only one channel is sent to the LCD projection TV, so you can not use the Twin View or Channel Index features for your cable box.)

- 1 Connect the Cable TV cable to the LCD projection TV's VHF/UHF jack.
- 2 Using a coaxial cable, connect the LCD projection TV's TO CONVERTER jack to the cable box's IN jack. The LCD projection TV's internal converter allows you to switch between unscrambled signals coming straight into the LCD projection TV and scrambled signals coming in through the cable box, eliminating the need for an external splitter.

- Using a coaxial cable, connect the cable box's OUT jack to the LCD projection TV's AUX jack.

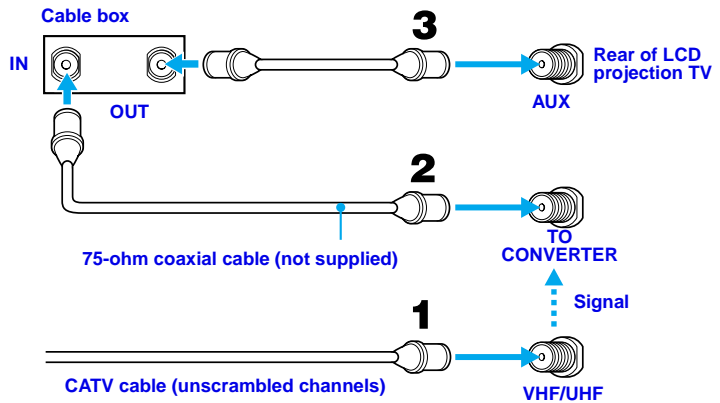

 Pressing ANT on the remote control switches between the channels coming in through the cable box (scrambled) and those coming directly to the TV (unscrambled).

Cable Box Only

Use this hookup if:

- ❑ You subscribe to a cable TV system that uses scrambled or encoded signals requiring a cable box to view all channels, and
- ❑ You do not intend to hook up any other audio or video equipment to your LCD projection TV.

When all channels are routed through your cable box, only one unscrambled channel is sent to the LCD projection TV, so you cannot use the Twin View feature. If some channels are scrambled, but others are not, consider using the hookup on page 26 instead.

- 1 Connect the coaxial connector from your cable service to the cable box's IN jack.
- 2 Using a coaxial cable, connect the cable box's OUT jack to the LCD projection TV's VHF/UHF jack.

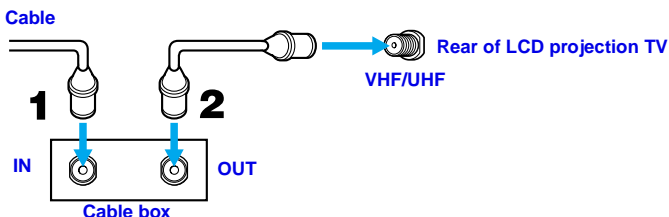

Also, set Cable to ON in the Channel menu (see page 62).

 Your Sony remote control can be programmed to operate your cable box (see "Programming the Remote Control" on page 77).

 To change channels using the cable box, set your LCD projection TV to channel 3 or 4 depending on the cable box channel output. If you will be controlling all channel selection through your cable box, consider using the Channel Fix feature to set your LCD projection TV to channel 3 or 4 (see page 63).

 Setting the Channel Fix feature in the Channel menu (see "Using the Channel Menu" on page 62), ensures that you do not accidentally switch the channels using your LCD projection TV.

Connecting a VCR and Cable

Use this hookup if:

- ❑ You have cable TV that does not require a cable box.

Disconnect all power sources before making any connections.

- 1 Connect the cable TV cable to the VCR's IN jack.
- 2 Using a coaxial cable, connect the VCR's OUT jack to the LCD projection TV's VHF/UHF jack.
- 3 Using AUDIO and S VIDEO cables, connect the VCR's Audio and S Video OUT jacks to the LCD projection TV's AUDIO and S VIDEO IN jacks.

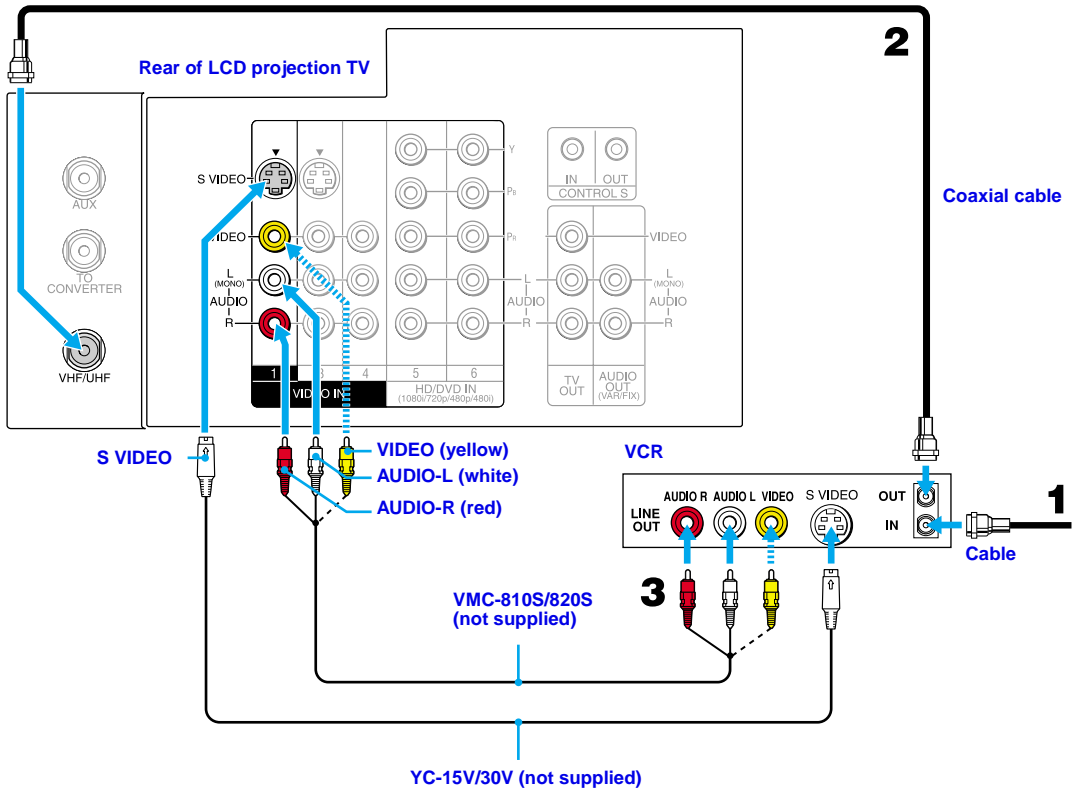

If your VCR is not equipped with S VIDEO, use a VIDEO cable (yellow) instead of the S VIDEO cable.

Connecting a VCR and Cable Box

Use this hookup if:

- ❑ Your cable TV company scrambles some channels, but not all of them (pay channels vs. regular cable channels) and you need to use a cable box, and
- ❑ You want to enjoy the Twin View feature.

With this setup you can:

- ❑ Use the LCD projection TV remote control to change channels on your cable box when the signal is scrambled. To program your Sony remote control to operate your cable box, see “Programming the Remote Control” on page 77.
- ❑ Use the LCD projection TV remote control to change channels using your LCD projection TV when the signal is not scrambled. Your LCD projection TV’s tuner provides a better signal than the cable box.
- ❑ Use the Twin View feature. (When all channels are routed through your cable box, only one signal is sent to the LCD projection TV, so you cannot use the Twin View feature.)

Disconnect all power sources before making any connections.

- 1 Connect the Cable TV cable to the LCD projection TV’s VHF/UHF jack.
- 2 Using a coaxial cable, connect the LCD projection TV’s TO CONVERTER jack to the cable box’s IN jack. The LCD projection TV’s internal converter allows you to switch between unscrambled signals coming straight into the LCD projection TV and scrambled signals coming in through the cable box, eliminating the need for an external splitter.
- 3 Using a coaxial cable, connect the cable box’s OUT jack to the VCR’s IN jack.
- 4 Using AUDIO and S VIDEO cables, connect the VCR’s AUDIO and S VIDEO OUT jacks to the LCD projection TV’s AUDIO and S VIDEO IN jacks.
- 5 Using a coaxial cable, connect the VCR’s OUT jack to the LCD projection TV’s AUX jack.

 To view scrambled channels, set your LCD projection TV to AUX 3 or 4 (depending on your cable box output). Change channels using your cable box.

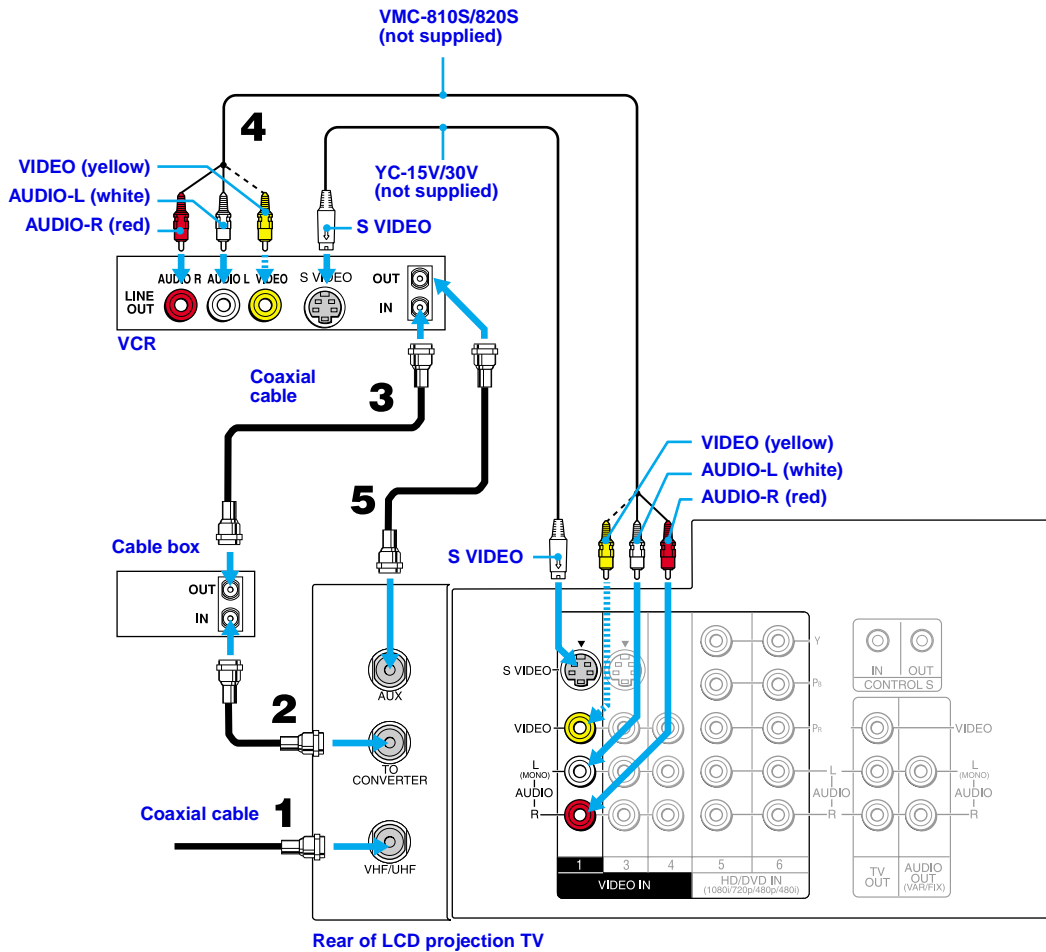

- If your VCR is not equipped with S VIDEO, use a VIDEO cable (yellow) instead of the S VIDEO cable.
- You will not be able to change channels on the VCR. Set your LCD projection TV and VCR to channel 3 or 4, depending on your cable box channel output.
- Pressing ANT on the remote control switches between the channels coming in through the cable box (scrambled) and those coming directly to the LCD projection TV (unscrambled).

Connecting Two VCRs for Tape Editing

If you connect two VCRs, you can record from one VCR to the other while using your LCD projection TV to monitor what is being recorded.

Disconnect all power sources before making any connections.

- 1 Using AUDIO and VIDEO cables, connect the playback VCR's Audio and Video OUT jacks to the recording VCR's Audio and Video IN jacks.
- 2 Using AUDIO and VIDEO cables, connect the recording VCR's AUDIO and Video OUT jacks to the LCD projection TV's AUDIO and VIDEO IN jacks.

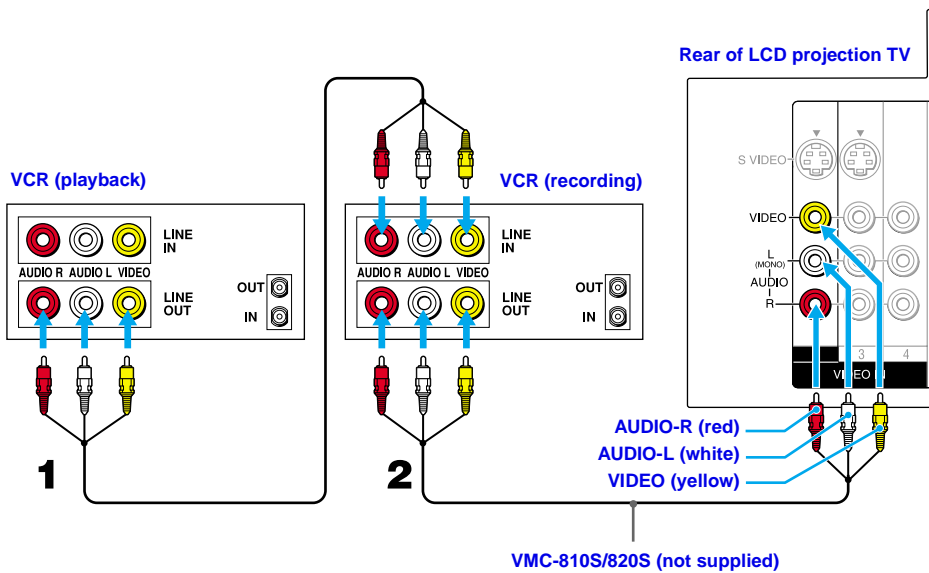

- To perform tape editing, set the LCD projection TV to the video input intended for playback by pressing TV/VIDEO on the remote control.
- You may need to change the video input on your VCR. Consult your VCR's operating manual for instructions.
- If your VCRs have an S VIDEO jack: For best picture quality, use an S VIDEO connection instead of the yellow video cable on your combined A/V cable.
Using an S VIDEO cable, connect the playback VCR's S VIDEO OUT jack to the recording VCR's S VIDEO IN jack. S VIDEO does not provide audio, so audio cables must be connected to provide sound.
- You cannot record signals from equipment connected to the Y, P_B, P_R input.

Connecting a Satellite Receiver

Disconnect all power sources before making any connections.

- 1 Connect the satellite antenna cable to the satellite receiver's SATELLITE IN jack.
- 2 Using AUDIO and S VIDEO cables, connect the satellite receiver's AUDIO and S VIDEO OUT jacks to the LCD projection TV's AUDIO and S VIDEO IN jacks.
- 3 Connect a coaxial cable from your cable or antenna to the LCD projection TV's VHF/UHF jack.

 If your satellite receiver is not equipped with S VIDEO, use a VIDEO cable (yellow) instead of the S VIDEO cable.

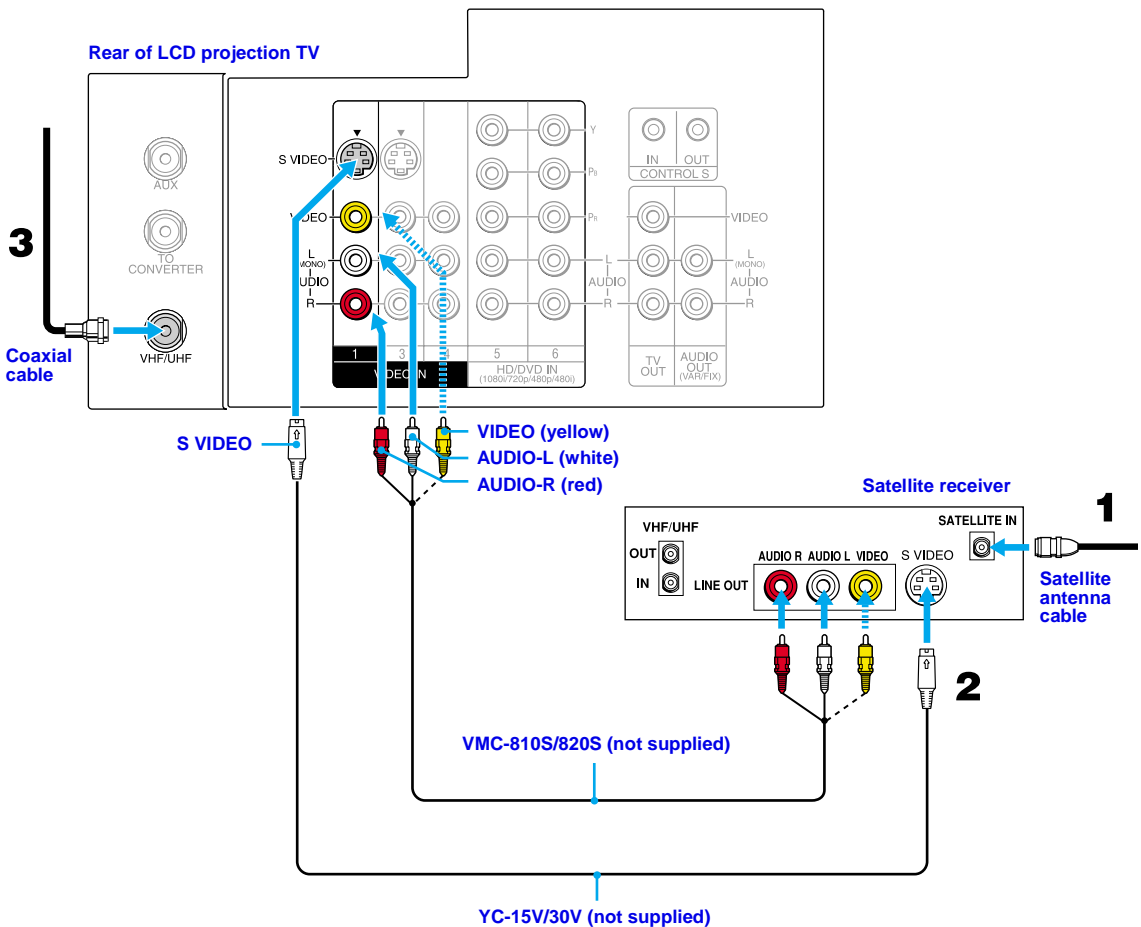

Connecting a Satellite Receiver with a VCR

Disconnect all power sources before making any connections.

- 1 Connect the satellite antenna cable to the satellite receiver's SATELLITE IN jack.
- 2 Connect the CATV cable to the VCR's VHF/UHF IN jack.
- 3 Using a coaxial cable, connect the VCR's OUT jack to the LCD projection TV's VHF/UHF jack.
- 4 Using AUDIO and S VIDEO cables, connect the satellite receiver's AUDIO and S VIDEO OUT jacks to the VCR's AUDIO and S VIDEO IN jacks.
- 5 Using AUDIO and S VIDEO cables, connect the VCR's AUDIO and S VIDEO OUT jacks to the LCD projection TV's AUDIO and S VIDEO IN jacks.

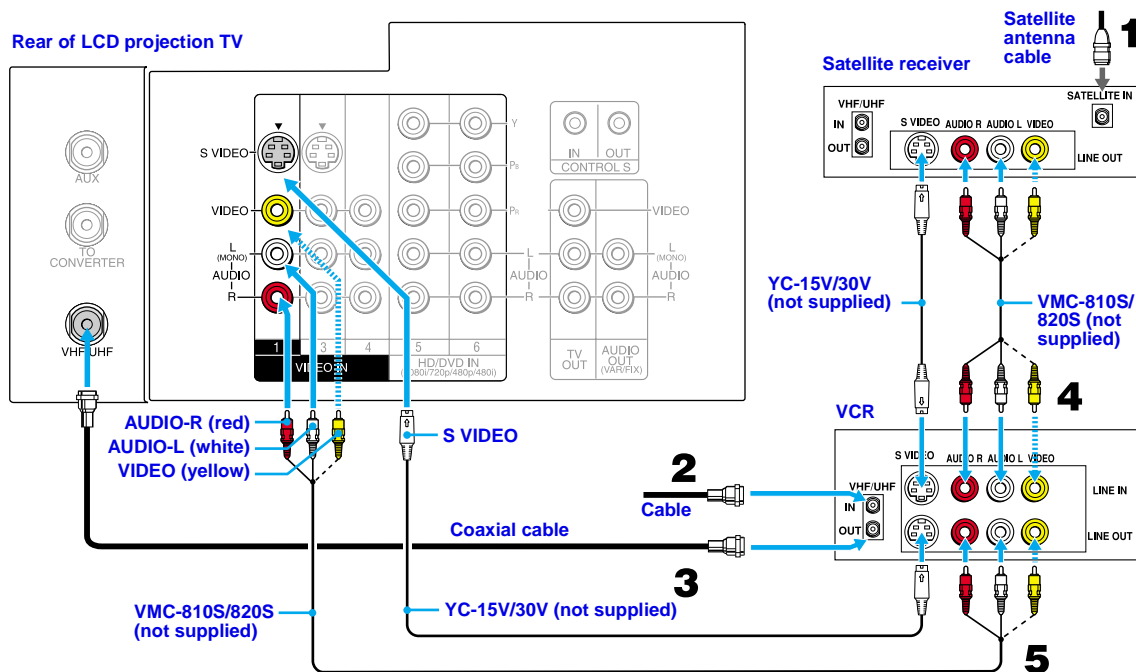

- Be sure your VCR's video input is set correctly. Consult your VCR's operating manual for instructions.
- Use TV/VIDEO to select
 - VIDEO 1 to watch satellite TV or the VCR (your VCR must be turned on).
 - VHF/UHF to watch cable TV.
- If your VCR or satellite receiver is not equipped with S VIDEO, use a VIDEO cable (yellow) instead of the S VIDEO cable.

Connecting an Audio Receiver

Disconnect all power sources before making any connections.

Using audio cables, connect the LCD projection TV's AUDIO OUT (VAR/FIX) jacks to the audio receiver's audio LINE IN jacks.

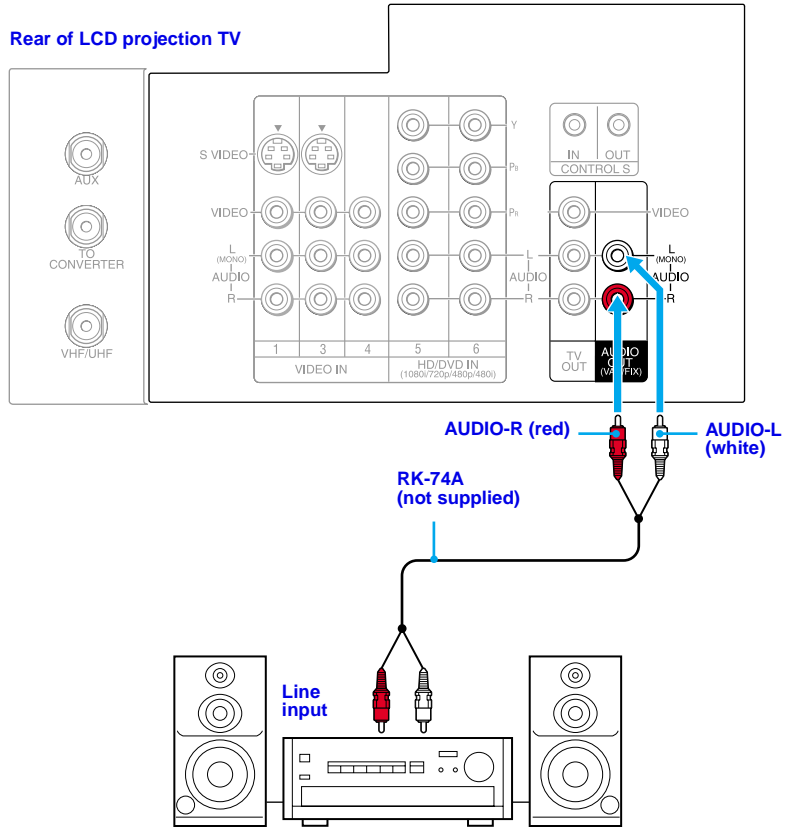

Connecting a DVD Player with Component Video Connectors

This is the preferred hookup to use if:

- ❑ Your DVD player has component (Y, B-Y, R-Y) jacks.

Disconnect all power sources before making any connections.

- 1 Using three separate component video cables, connect the DVD player's Y, B-Y and R-Y jacks to the Y, PB and PR jacks on the LCD projection TV. Use the HD/DVD IN 5 or 6 connections.

 The Y, B-Y and R-Y jacks on your DVD player are sometimes labeled Y, C_B and C_R, or Y, P_B and P_R. If so, connect the cables to like colors.

- 2 Using an audio cable, connect the DVD player's Audio OUT jacks to the LCD projection TV's AUDIO IN jacks. Be sure to use the same row of inputs that you used for the video connection (HD/DVD IN 5 or 6).

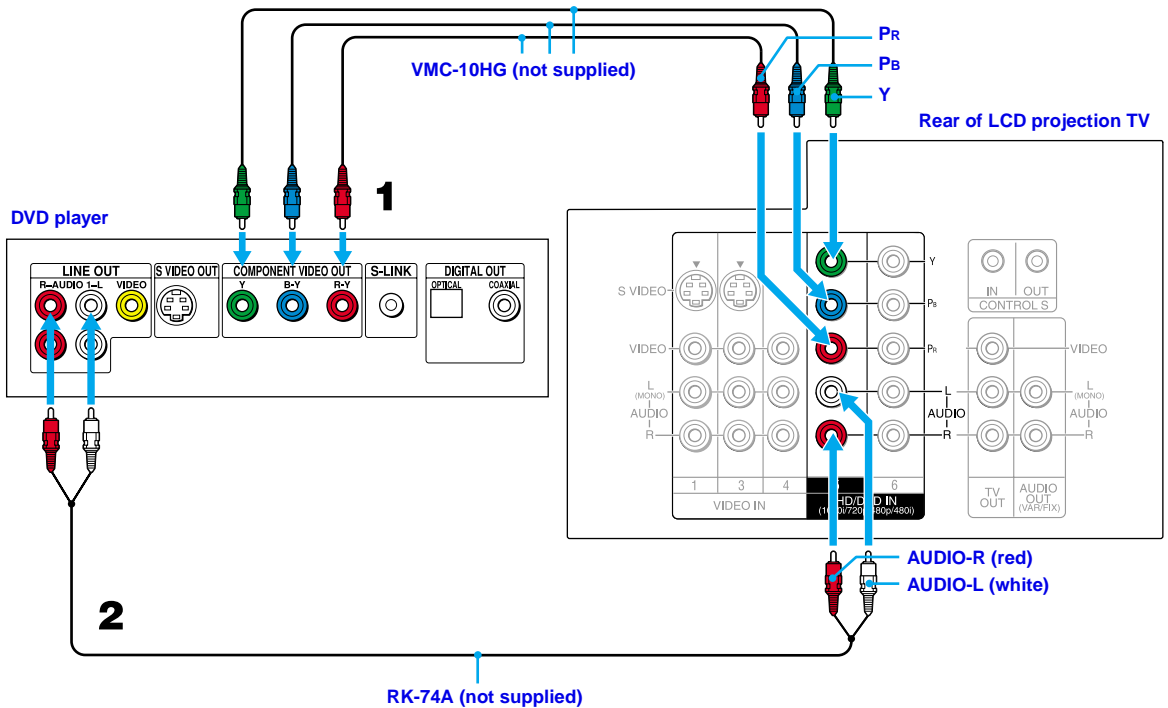

 To take advantage of the Wide Screen modes, set the TV's aspect ratio to 16:9 on your DVD player. For details, refer to the operating instructions supplied with your DVD player.

Connecting a DVD Player with A/V Connectors

Use this hookup if:

- ❑ Your DVD player does not have component (Y, PB, PR) jacks.

🔧 If your DVD player has video component output connectors: for best picture quality use the connection described on page 36.

Disconnect all power sources before making any connections.

- 1 Using audio cables, connect the DVD player's Audio OUT jacks to the LCD projection TV's AUDIO IN jacks.
- 2 Using an S VIDEO cable, connect the DVD player's S VIDEO jack to the LCD projection TV's S VIDEO jack.

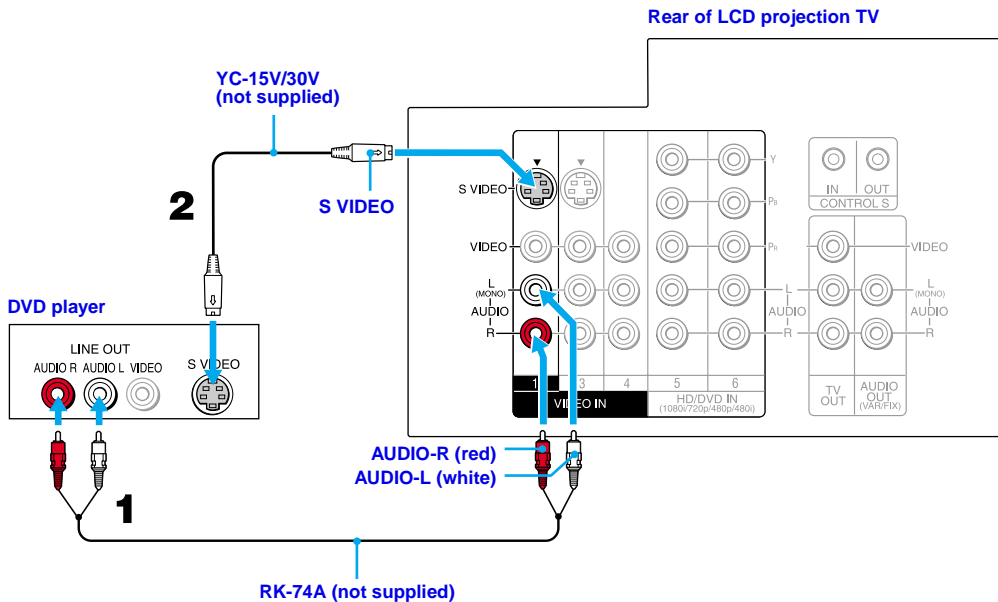

🔧 To take advantage of the Wide Screen modes, set the TV's aspect ratio to 16:9 on your DVD player. For details, refer to the operating instructions supplied with your DVD player.

🔧 Use TV/VIDEO on the remote control to switch between the VCR, DVD player and cable TV inputs.



🔧 If your VCR is not equipped with S VIDEO, use a VIDEO cable (yellow) instead of the S VIDEO cable.

Connecting a Digital TV Receiver

 Be sure to read the Set-top box manual.



Disconnect all power sources before making any connections.

- 1 Using three separate component video cables, connect the Digital TV Set-top box's Y, PB and PR jacks to the LCD projection TV.

-  The Y, PB and PR jacks do not provide audio, so audio cables must be connected to provide sound.
-  Component video connection is necessary to view 480i, 480p, 720p, and 1080i formats. You may also use the S VIDEO or Composite Video connections, however, component video (Y, PB, PR) will provide the best picture quality for all format types.

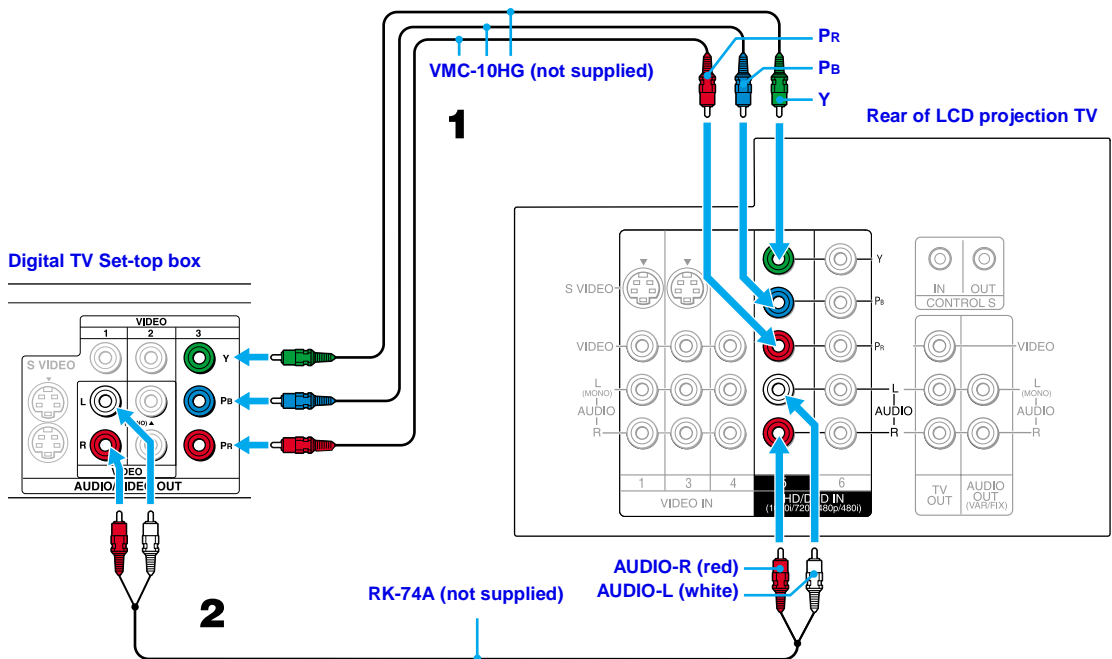
- 2 Using an audio cable, connect the Digital TV Set-top box's Audio OUT jacks to the LCD projection TV's AUDIO IN jacks.





-  You cannot record the signal from any equipment connected into the Y, PB and PR connectors.
-  This LCD projection TV is not compatible with digital TV receivers configured with RGB or VGA output connectors.

Connecting a Camcorder

For easy connection of the camcorder, the LCD projection TV has side Audio and Video inputs (shown below). However, if you prefer, you can also connect the camcorder to the LCD projection TV's rear Audio and Video IN jacks.

Using AUDIO and S VIDEO cables, connect the camcorder's Audio and S VIDEO OUT jacks to the LCD projection TV's AUDIO and S VIDEO IN jacks.

-  If you have a mono camcorder, connect its left audio output to the LCD projection TV's AUDIO L (MONO) jack.
-  If your camcorder is not equipped with S VIDEO, use a VIDEO cable (yellow) instead of the S VIDEO cable.

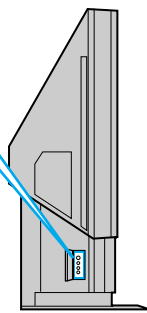
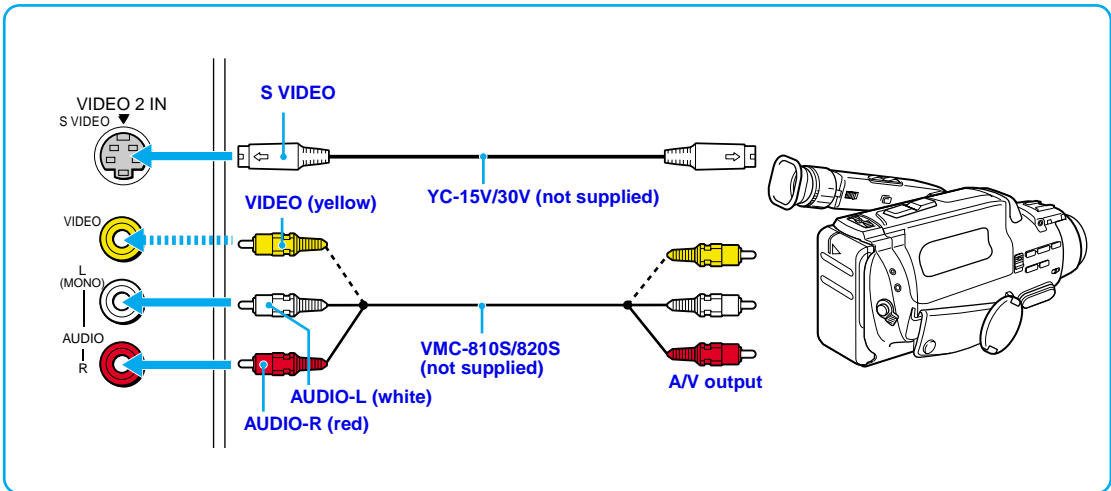

Connecting an AV Receiver

For greater control of all audio and video equipment, connect an AV receiver.

 Change "Video Label" for the VIDEO 1 input to "Receiver" (see page 68).

Disconnect all power sources before making any connections.

- 1 Connect the coaxial cable from the incoming cable connection or antenna to IN on the VCR.
- 2 Using a coaxial cable, connect OUT on the VCR to VHF/UHF on the LCD projection TV.
- 3 Using a VIDEO cable, connect VIDEO of VIDEO 1 IN on the LCD projection TV to MONITOR OUT on the AV receiver.
- 4 Using an AUDIO/VIDEO cable, connect TV OUT on the LCD projection TV to AUDIO/VIDEO 2 IN on the AV receiver.
- 5 Using an AUDIO/VIDEO cable, connect the video equipment to the AV receiver.
- 6 Select the Setup menu and set "Video Label" to "Receiver" to fix your LCD projection TV's input to AV receiver (see "Video Label" on page 68).

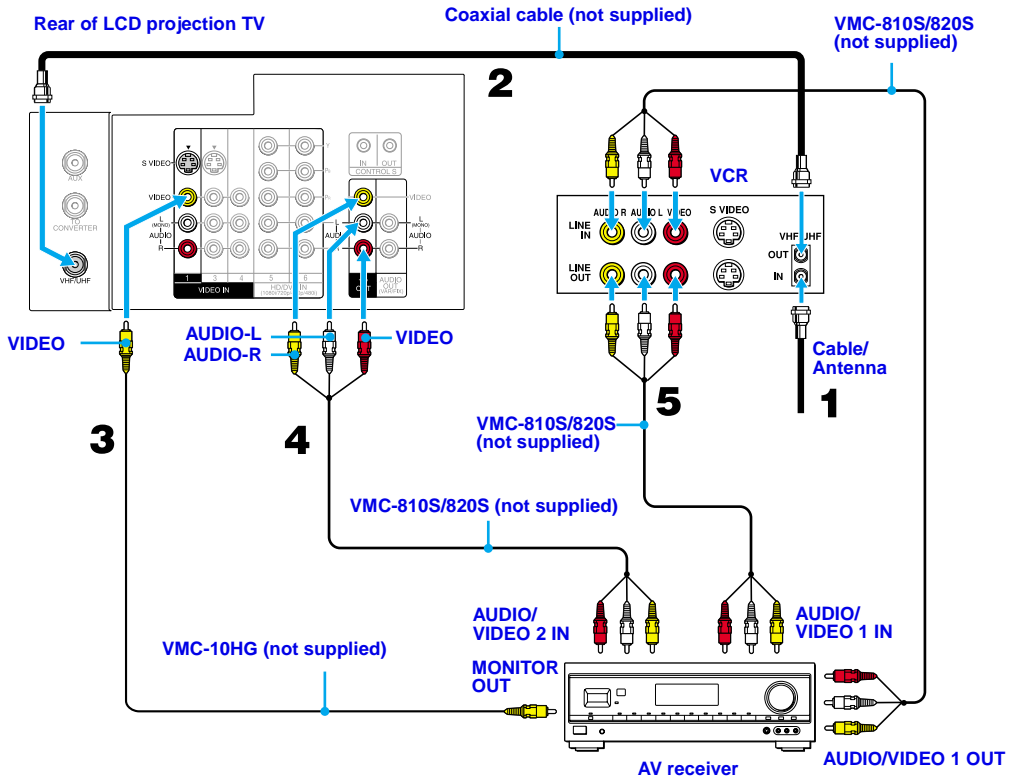

Using the CONTROL S Feature

CONTROL S allows you to control your LCD projection TV system and other Sony equipment with one remote control. In addition to allowing you to control multiple devices with one remote control, the CONTROL S feature allows you to always point your remote control at your LCD projection TV, instead of having to point it at the other equipment, which might be hidden or out of direct line of sight.

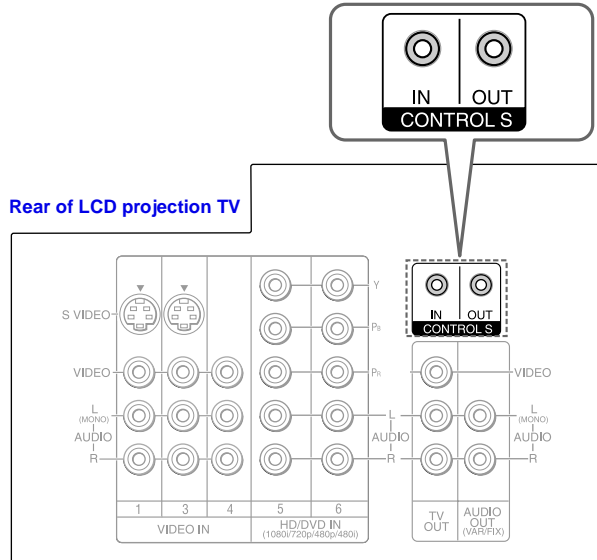

Setting Up the LCD projection TV Automatically

After you finish connecting your LCD projection TV, you can run Auto Setup to set up your channels. The Auto Setup screen appears when you turn your LCD projection TV on for the first time after installing it. If you do not want to set up the channels at this time, you can do it later by using the Auto Program feature in the Channel menu (see page 63).

 The Auto Setup feature does not apply for installations that use a cable box for all channel selection.

Using Auto Setup

- 1 Press POWER on the front panel of your LCD projection TV or on the remote control to turn on the LCD projection TV.
- 2 Press the TV (FUNCTION) button on your remote control. Red light will briefly appear.
- 3 Press CH+ on your LCD projection TV to run Auto Setup, or press CH- to exit. If you use the channel buttons on your remote control, be sure to use the main set of buttons (.

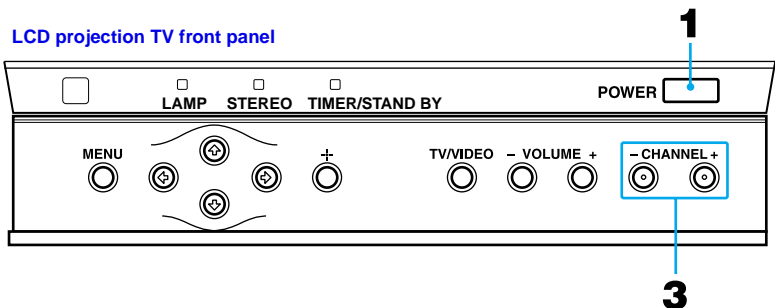

 You can run Auto Program by selecting it in the Channel menu, as described on page 63.

Using the Features

Using the Remote Control

The following table describes the buttons on the remote control that are for more advanced functions.

Button Descriptions

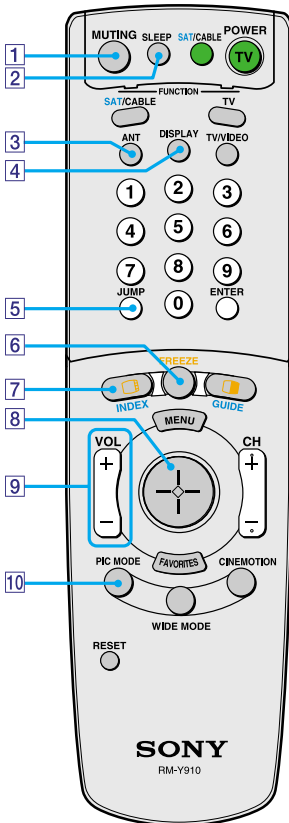



Outside Panel

Button	Description
1 MUTING	Press to mute the sound. Press again or press VOL + to restore the sound.
2 SLEEP	Press repeatedly until the LCD projection TV displays the time in minutes (15, 30, 45, 60, or 90) that you want the LCD projection TV to remain on before shutting off automatically. To cancel Sleep timer, press SLEEP repeatedly until SLEEP OFF appears. Pressing down POWER also cancels the Sleep timer and turns off the power. While the Sleep feature is set, press once to view the remaining time.
3 ANT	Changes between the VHF/UHF input and the AUX input.
4 DISPLAY	Press once to display the current time and channel label (if set) and channel number. Press again to turn Display off. See page 66 for details on setting the time.
5 JUMP	Press to jump back and forth between two channels. The LCD projection TV alternates between the current channel and the last channel that was selected.
6 FREEZE	Freezes the window picture. Press again to restore the picture.
7 INDEX	Press to enter the Scrolling Channel Index mode. You can view and select from all receivable channels scrolling on the screen without leaving the current one.
8 	The joystick allows for movement of the on-screen cursor. Pressing down on the center of the joystick selects the item.
9 VOL +/-	Adjusts the volume.
10 PIC MODE	Press repeatedly to step through the available video picture modes: Vivid, Standard, Movie and Mild. Also available in the Video menu. For details, see "Selecting Video Options" on page 58.

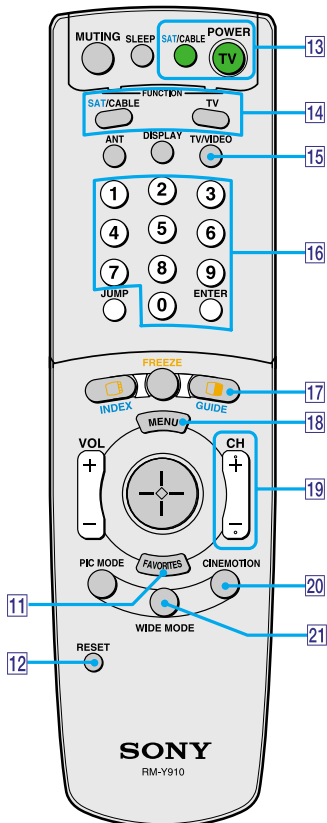
(Continued)



Button	Description
11 FAVORITES	Displays the Favorite Channels list. For details, see “Using Favorite Channels” on page 49.
12 RESET	Press when in a menu to reset the settings to the factory defaults.
13 POWER buttons (GREEN)	Turn on and off the LCD projection TV and other audio/video equipment you have programmed into the remote control. For instructions, see “Programming the Remote Control” on page 77.
14 FUNCTION buttons	Select the equipment (TV, SAT/CABLE) that you want to operate. The indicator lights up momentarily when pushed to show which device the remote control is operating.
15 TV/VIDEO	Cycles through the video equipment connected to your LCD projection TV’s video inputs: TV, VIDEO 1, VIDEO 2, VIDEO 3, VIDEO 4, VIDEO 5 and VIDEO 6.
16 0 – 9 and ENTER	Press 0 - 9 to select a channel, the channel changes after 2 seconds. Press ENTER to select immediately.
17 	Turns on/off Twin View. For details, see “Using Twin View™” on page 50.
GUIDE	Displays the program guide of your satellite.
18 MENU	Press to display the LCD projection TV on-screen menu. Press again to exit from the menu.
19 CH +/-	Scan through channels.  To scan rapidly through the channels, press and hold down CH+ or CH-.
20 CINEMOTION	Press to turn on and off the CineMotion mode. For details, see “Using the Video Menu” on page 58.
21 WIDE MODE	Press to step through the wide screen modes: Wide Zoom, Normal, Full and Zoom. For details, see “Using Wide Screen Mode” on page 56.

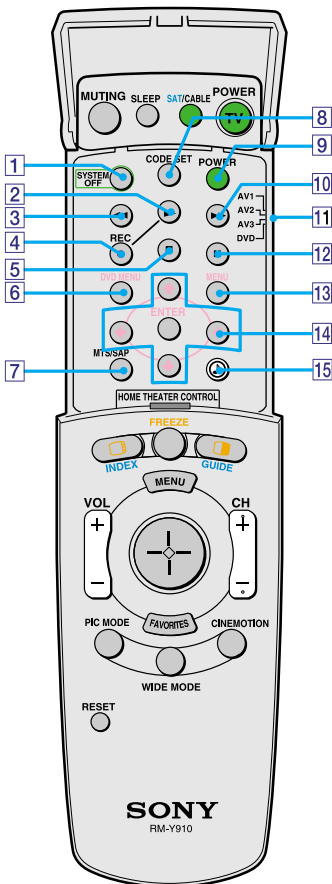

Inside Panel

Button	Description
1 SYSTEM OFF	Press to turn off the LCD projection TV and all equipment connected with S-Link.
2 ▶	Play
3 ◀◀	Rewind
4 REC	Record
5 ■	Stop
6 DVD MENU	Displays the DVD menu.
7 MTS/SAP	Press to scroll through the Multi-channel TV Sound (MTS) options: Stereo, Auto SAP, and Mono.
8 CODE SET	Used for programming the remote control to operate non-Sony video equipment. For details, see “Programming the Remote Control” on page 77.
9 POWER	Press to turn on the DVD/VCR player you have programmed into the remote control. For instructions, see “Programming the Remote Control” on page 77.
10 ▶▶	Fast-forward
11 AV1 AV2 AV3 DVD	Use to switch control for connected video equipment. You can program one video source for each switch position. For details, see “Programming the Remote Control” on page 77.
12	Pause (Press again to resume normal playback)
13 MENU	Displays the Video equipment menu.
14 ↑, ↓, ←, →, and ENTER	Use to operate the DVD menu.
15 🎵	Press to select an audio option: Steady Sound ON or OFF.

Watching the TV

Many TV features can be accessed directly through the remote control. The following will explain the function of some of the buttons found on your remote control.

Buttons for LCD Projection TV Operations

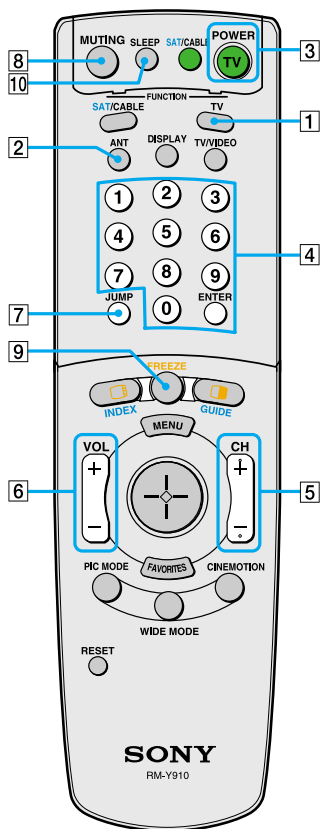

1 TV (FUNCTION)

Activates the remote control for use with the LCD projection TV.

2 ANT— (AUX input)

Press to change between the VHF/UHF input and the AUX input.

3 TV (POWER)

Turns the LCD projection TV on and off. If a video input indication (e.g., VIDEO 1, VIDEO 2) appears on the screen, press TV/VIDEO or CH +/- until a channel number appears.

4 0-9 and ENTER

Use for direct channel selection. Press 0-9 to select a channel (for example, to select channel 10, press 1 and 0). The channel will change after 2 seconds, or you can press ENTER for immediate selection.

5 CH +/-

Press to scan through the channels (+ up or – down).

6 VOL +/-

Press to adjust the volume (+ up or – down).

7 JUMP

Press to alternate or jump back and forth between two channels. The LCD projection TV will jump between the current channel and the last channel selected.

8 MUTING

Press to mute the sound. “MUTING” will appear on the screen and will dim three seconds later. To restore the sound, press again or press VOL +.

9 FREEZE — (yellow labeled button)

This is useful when you need to copy down information that appears on the LCD projection TV’s screen (see “Using the Freeze Function” on page 53).

10 SLEEP

Press repeatedly until the LCD projection TV displays the approximate time in minutes (15, 30, 45, 60, or 90) that you want the LCD projection TV to remain on before shutting off automatically.

Cancel by pressing SLEEP until “SLEEP OFF” appears.

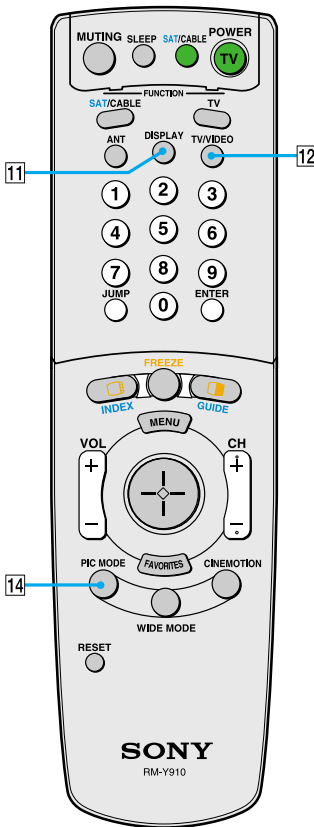
**11 DISPLAY**

Press to display the channel number, current time and channel label (if set).

To turn the display off, press DISPLAY again.

12 TV/VIDEO

Press repeatedly to scroll through available video inputs: TV, VIDEO 1, VIDEO 2, VIDEO 3, VIDEO 4, VIDEO 5 and VIDEO 6.

If you select Skip as a Video Label in the Setup menu, your LCD projection TV will skip the video input you selected (see “Video Label” on page 68).

13 MTS/SAP

Press to scroll through the Multi-channel TV Sound (MTS) options (see “MTS” on page 61).

14 PIC MODE

Press PIC MODE repeatedly to directly choose one of four different video modes that best suits the program you are watching.

Vivid: Select for enhanced picture contrast and sharpness.

Standard: Select to display a standard picture for normal viewing environments.

Movie: Select to smooth the outline of digital image.

Mild: Select to display a picture with minimum enhancements.

When you select each mode, you can also adjust the picture quality (such as Brightness, Color, etc.) to suit your taste. For details, see “Mode” on page 58.

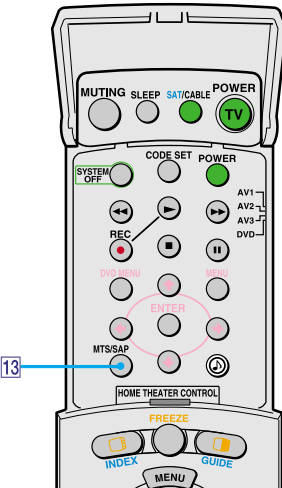

Watching the Digital TV

When you have connected the DTV receiver, you can enjoy digital TV programs. This LCD projection TV is capable of receiving the 1080i, 720p*, 480p and 480i digital TV formats.

- * This LCD projection TV is not capable of displaying a native 720p format signal. Therefore, when a native 720p format signal is received, it is converted into a 480p format signal.

To view a digital TV program

- 1** Connect the DTV receiver to HD/DVD IN 5 or 6 on the LCD projection TV (for details, see page 38).
- 2** Press TV/VIDEO to select HD/DVD IN 5 or 6.
- 3** Select a digital channel on the DTV receiver. For details, see the Operating Manual of the DTV receiver.
- 4** Adjust the volume of the LCD projection TV as necessary.

Using Favorite Channels

The Favorite Channel feature lets you select programs from a list of favorite channels that you preset.

To display a list of your favorite channels:

 Your Favorite Channel options can be set automatically or manually. The factory setting for Favorite Channel is Auto. When Favorite Channel is set to Auto, the last eight channels selected with 0-9 buttons will be set as Favorite Channel options. If you want to input your own selections as Favorite Channel settings, see "Favorite Channel" on page 62.

- 1 Press FAVORITES.

The Favorite Channel options appear.



- 2 Move the joystick up or down to highlight the channel you want to watch. The program of that channel appears in the preview window. Press  to select.

Using Twin View™

Twin View enables you to watch two programs at the same time. You can also change the size of both the left and right pictures.



Activating Twin Pictures

To display twin pictures

- 1 Make sure your LCD projection TV is tuned to a working channel.
- 2 Press .



To cancel twin pictures

- Press  again (or press .

Activating the Picture

Although two pictures appear on the screen at the same time, only one picture is active. Change the picture size by using the joystick. For an active picture, you can:

- Change channels.
- Adjust the volume.
- Switch the input sources from VHF/UHF to cable by pressing ANT or TV/VIDEO to switch the video input.

To activate the right picture

- Move the joystick to the right.



To activate the left picture

- Move the joystick to the left.

 Hookups that affect your ability to use Twin View:

- If you are viewing all channels through the cable box, the Twin View feature will not work. The cable box only unscrambles one signal at a time, so the right picture will be the same as the left picture.
- You can watch a scrambled cable channel and another video source. Be sure your DVD player, VCR or satellite receiver are connected to one of the VIDEO IN 1-6 and AUX inputs on the rear of the LCD projection TV. Pictures from equipment connected to HD/DVD IN 5 and 6, and AUX will only appear in the left picture, not in the right.

 The active picture is highlighted in cyan.

Changing the Picture Size

The zoom feature lets you change the size of the left and right pictures.

To enlarge the left picture (reduce the right)

- 1 Move the joystick left to activate the left picture (if not already activated).
- 2 Move the joystick up to enlarge the picture and move the joystick down to reduce the picture.

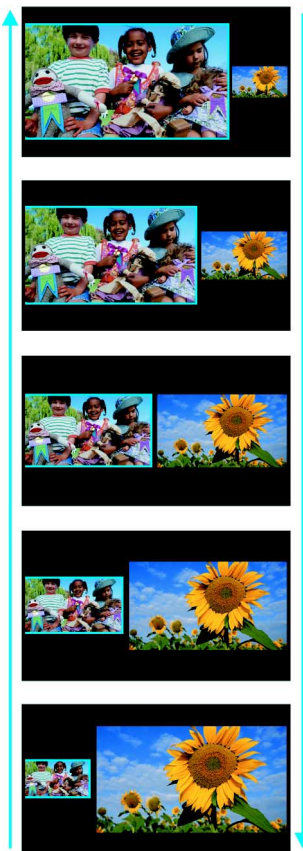

To enlarge the right picture (reduce the left)

- 1 Move the joystick right to activate the right picture (if not already activated).
- 2 Move the joystick up to enlarge the picture and move the joystick down to reduce the picture.

 When you adjust the twin screen sizes, the LCD projection TV memorizes the change. The next time you use the Twin View function, the memorized sizes appear.

Using the Freeze Function

The FREEZE button allows you to temporarily capture a program's picture. You can use this feature to write down information such as phone numbers, recipes, etc.

To use the Freeze function

- 1 When the program information you want to capture is displayed, press FREEZE.
- 2 The LCD projection TV switches to Twin View mode and displays the "frozen" picture on the right, while the current program continues on the left.



- 3 To cancel and return to normal viewing, press FREEZE.

 Freeze feature is not available if you are already in Favorite Channel (see page 49), Twin View™ (see page 50), or Channel Index (see page 54) mode.

Using Scrolling Channel Index

Scrolling Channel Index allows you to view and select from all receivable channels scrolling on the screen without leaving the current channel.

 Scrolling Channel Index will not function when Parental Lock is activated.

To use the Scrolling Channel Index function

1 Press .

The current channel will be reduced in size and displayed on the left in normal motion picture format. The first channel is briefly displayed on the bottom-right side of the screen, then frozen. It scrolls up and the next channel appears on the bottom-right, and the process is repeated with the other channels.

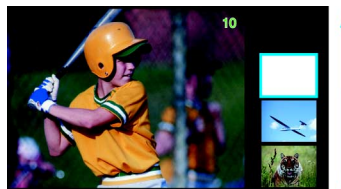

2 Move the joystick up and down so that the channel you wish to view is displayed in the cyan frame, and press .

To return to scrolling, move the joystick up and down again.



 To change the direction of scrolling, move the joystick up or down once.

To increase scrolling speed, hold the joystick up or down.

- 3 To enlarge the selected channel into the left frame, press  again. The selected channel will be displayed in normal motion picture, and the sound also switches to this channel.



- 4 Press . The selected channel will be enlarged for normal viewing.



To cancel Scrolling Channel Index

Press  again to resume normal viewing.

Using Wide Screen Mode

Wide Screen Mode lets you watch 4:3 normal broadcasts in several Wide Screen Modes (16:9 aspect ratio).

- ❑ Press WIDE MODE repeatedly to toggle through the following Screen Mode settings.

 You can also access the Screen Mode settings in the Wide menu. For details, see page 64.

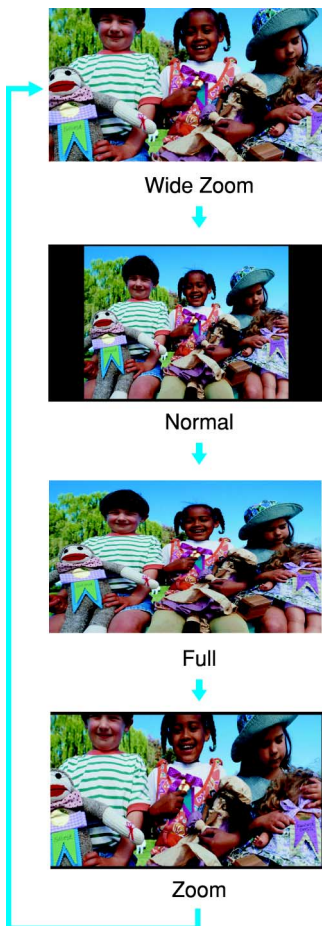

Wide Zoom enlarges the 4:3 picture to fill the 16:9 screen, keeping the original image as much as possible.

Normal returns the 4:3 picture to its original size.

Full Mode stretches the 4:3 picture horizontally only, to fill the 16:9 screen.

Zoom Mode enlarges the 4:3 picture horizontally and vertically to an equal aspect ratio that fills the 16:9 screen. Useful for watching Letterbox movies.

 When you change channels or inputs, the Screen Mode settings revert to Wide Zoom (or the 4:3 Default setting in the Wide menu). To retain the current Screen Mode setting as channels and inputs are changed, set 4:3 Default to Off. For details, see page 65.

Using the Menus

Overview

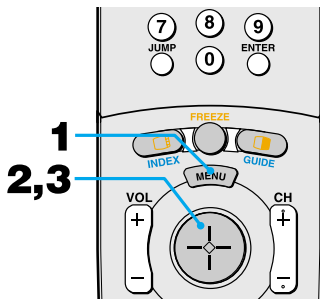





Opening and choosing a menu

- 1 Press MENU to display the menu screen.
- 2 Move the joystick to the desired menu icon and press  to select it.
- 3 Use the joystick to scroll through the features.
- 4 See the specific menu page for instructions on moving through the menu.







To end a menu session

- ❑ Press MENU again.

To end one menu session and move to another

- ❑ Press the joystick  to return to the menu icons. Move the joystick  or  to choose the next menu icon and press  to select it.





The menu gives you access to the following features:

<i>Menu Icon</i>	<i>Description</i>	<i>Page</i>
	Allows you to make adjustments to your picture settings. It also allows you to customize the Picture Mode based on the type of program you are viewing.	58
	Offers enhanced audio options such as listening to second audio programming (SAP), or customizing the Effect of the sound on your LCD projection TV.	60
	Allows you to set up a Favorite Channel list, run the Auto Program function, and more.	62
	Allows you to set the wide screen mode, adjust the vertical center in wide mode, and set the 4:3 Default mode.	64
	Lets you set the clock on your LCD projection TV and allows you to program your LCD projection TV for scheduled viewing using the Timers.	66
	Provides several options for setting up your channels, labeling your Video inputs, and selecting the language of the on-screen menus.	67



Using the Video Menu

To select the Video Menu

- 1 Press MENU.
- 2 Move the joystick to the Video icon  and press .
- 3 Use the joystick to scroll through the features.
- 4 Press  to select a feature. That feature's adjustment appears.
- 5 Use the joystick to make the desired adjustments.
- 6 Press  to select/set.
- 7 Press MENU to exit the menu screen.

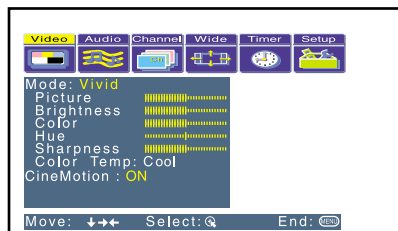



To restore the factory default settings for Picture, Brightness, Color, Hue, Sharpness and Color Temp

- Press RESET on the remote control when in the Video menu.

Selecting Video Options

The Video menu includes the following options.





Option	Description
Mode	Vivid Select for enhanced picture contrast and sharpness.
<i>Customized picture viewing</i>	Standard Recommended for Normal viewing conditions.
	Movie Select for soft, film like, picture.
	Mild Select to smooth the outline of digital image.
	 You can alter the Video menu settings (Picture, Brightness, Color, etc.) for each Mode.
 To quickly and easily change from one Video Mode to another, use PIC MODE on the remote control.	
Picture	Adjust to increase picture contrast and deepen the color or decrease picture contrast and soften the color.
Brightness	Adjust to brighten or darken the picture.
Color	Adjust to increase or decrease color intensity.
Hue	Adjust to increase or decrease the green tones.
Sharpness	Adjust to sharpen or soften the picture.

<i>Option</i>	<i>Description</i>
Color Temp	Choose from three color temperatures:
<i>White intensity adjustment</i>	Cool Select to give the white colors a blue tint.
	Neutral Select to give the white colors a neutral tint.
	Warm Select to give the white colors a red tint.
CineMotion	Obtains a smooth picture movement that approaches the original film-like quality when reproducing movies or other video sources on 24 frame per second films.
	ON The LCD projection TV automatically detects the signal type of a film and processes it appropriately.
	OFF Select to turn off the CineMotion mode.
	 When the Video Mode is set to Mild (page 58), you cannot set CineMotion to ON.



Using the Audio Menu

To select the Audio Menu

- 1 Press MENU.
- 2 Move the joystick to the Audio icon  and press .
- 3 Use the joystick to scroll through the options.
- 4 Press  to select an option. That option's settings appear.
- 5 Use the joystick to scroll through the settings.
- 6 Press  to select the desired setting.
- 7 Press MENU to exit the menu screen.

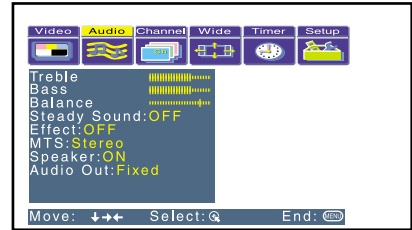

To restore the factory default settings for Treble, Bass and Balance

- ❑ Press RESET on the remote control when in the Audio menu.

Selecting Audio Options

The Audio menu includes the following options:





Option	Description
Treble	Adjust to increase or decrease higher-pitched sounds.
Bass	Adjust to increase or decrease lower-pitched sounds.
Balance	Adjust to emphasize left or right speaker balance.
Steady Sound	ON Select to stabilize the volume.
	OFF Select to turn off Steady Sound.
Effect	<input checked="" type="checkbox"/> Virtual Select for surround sound (for stereo programs only).
	 A virtual surround system attempts to create the same surround effect produced by a multichannel system using only the left and right speakers. Most effective for programs encoded in Dolby Surround.
	Simulated Adds a surround-like effect to mono programs.
	OFF Normal stereo or mono reception.

Option	Description	
MTS <i>Enjoy stereo, bilingual and mono programs</i>	Stereo	Select for stereo reception when viewing a program broadcast in stereo.
	Auto-SAP	Select to automatically switch the LCD projection TV to second audio programs when a signal is received. (If no SAP signal is present, the LCD projection TV remains in Stereo mode.)
	Mono	Select for mono reception. (Use to reduce noise during weak stereo broadcasts.)
Speaker	ON	Select to turn on the LCD projection TV speakers.
	OFF	Select to turn off the LCD projection TV speakers and listen to the LCD projection TV's sound only through your external audio system speakers.
Audio Out <i>Easy control of volume adjustments</i>	Variable	The LCD projection TV's speakers are turned off, but the volume output from your audio system can still be controlled by the LCD projection TV's remote control.
	Fixed	The LCD projection TV's speakers are turned off and the volume, bass and treble output of the LCD projection TV is fixed. Use your audio receiver's volume control to adjust the volume through your audio system.



Using the Channel Menu



To select the Channel Menu

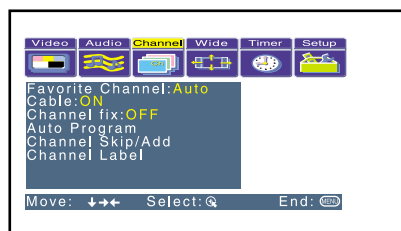

- 1 Press MENU.
- 2 Move the joystick to the Channel icon  and press .
- 3 Use the joystick to scroll through the features.
- 4 Press  to select a feature. That feature's options appear.
- 5 Use the joystick to scroll through the options.
- 6 Press  to select the desired option.
- 7 Press MENU to exit the menu screen.



Selecting Channel Options

The Channel menu includes the following options:





Option	Description
Favorite Channel Auto	Select if you want Favorite Channel options to be set automatically to the last eight channels selected with the 0-9 buttons.
Manual	Select if you want to input your own selections as Favorite Channel options. <ol style="list-style-type: none"> 1 Press  to select a favorite channel number. 2 Use the joystick to scroll through the channels until you find the channel you want to add to your favorites. 3 Press  to select it.
Cable ON	Select if you are receiving cable channels with a CATV cable.
OFF	Select if you are using an antenna.
 You should run Auto Program after changing the Cable setting.	

<i>Option</i>	<i>Description</i>
Channel Fix <i>Useful when you have a cable box or satellite receiver connected</i>	2-6 “Fix” your LCD projection TV’s channel setting to 3 or 4 and use the cable box, VCR or satellite receiver to change channels. Select one of these settings if you have connected the device to the VHF/UHF jack. <hr/> AUX 2-6 Same as 2-6, except you select one of these settings if you have connected the device to the AUX jack (see page 24). <hr/> VIDEO 1 Use when connecting a cable box. TV output should be connected through the cable box.
Auto Program	Automatically programs the LCD projection TV for all receivable channels.
Channel Skip/Add	Removes and adds viewable channels. <ol style="list-style-type: none"> 1 Use the joystick to scroll through the channels until you find the channel you want to skip/add. 2 Press  to select it. 3 Press the joystick up or down to toggle between “Add” and “Skip.” 4 Press  to select.
Channel Label	Label up to 20 channels with their station call letters.



Using the Wide Menu

To select the Wide menu

- 1 Press MENU.
- 2 Use the joystick to move to the Wide icon  and press .
- 3 Move the joystick to scroll through the features.
- 4 Press  to select a feature. That feature's options appear.
- 5 Use the joystick to scroll through the options.
- 6 Press  to select the desired option.
- 7 Press MENU to exit the menu screen.

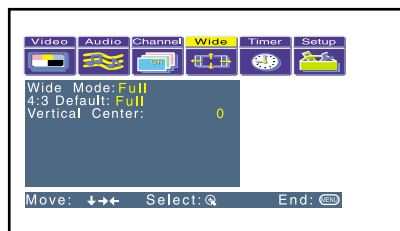



Selecting Wide Options

The Wide menu includes the following options:

 To change from one Screen Mode to another, use WIDE MODE on the remote control.



Option	Description	
Wide Mode	Wide Zoom	
<i>Select a Screen Mode to use for 4:3 sources.</i>	Normal	Select to return the 4:3 picture to normal mode.
	Full	Select to enlarge the 4:3 picture horizontally only, to fill the wide screen.
	Zoom	Select to enlarge the 4:3 picture horizontally and vertically to an equal aspect ratio that fills the wide screen.
	 Wide Mode is unavailable while in Twin View (page 50), Freeze (page 53), or Channel Index (page 54) mode.	

Option	Description
4:3 Default <i>Select the default Screen Mode to use for 4:3 sources.</i>	<p>Wide Zoom Select to enlarge the 4:3 picture, to fill the 16:9 screen, keeping the original image as much as possible.</p> <hr/> <p>Normal Select to return the 4:3 picture to normal mode.</p> <hr/> <p>Full Select to enlarge the 4:3 picture horizontally only, to fill the wide screen.</p> <hr/> <p>Zoom Select to enlarge the 4:3 picture horizontally and vertically to an equal aspect ratio that fills the wide screen.</p> <hr/> <p>Off Select to continue using the current Screen Mode setting when the channel or input is changed.</p>
	<p> The 4:3 Default functions only when the LCD projection TV receives 480i signals.</p> <p> If 4:3 Default is set to anything but Off, the Screen Mode setting changes only for the current channel. When you change channels (or inputs), Screen Mode is automatically replaced with the 4:3 Default setting. To retain the current Screen Mode setting as channels and inputs are changed, set 4:3 Default to Off.</p>
Vertical Center	<p>Allows you to move the position of the picture up and down in the window. (Available only in Wide Zoom and Zoom modes.)</p> <p>Move the joystick up or down to choose a position and press .</p>





Using the Timer Menu

To select the Timer menu

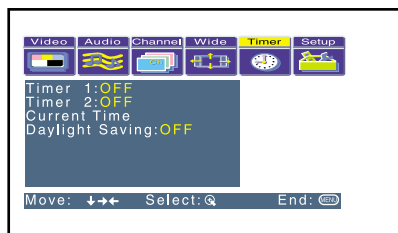
- 1 Press MENU.
- 2 Move the joystick to the Timer icon  and press .





To set the Current Time

- 1 Use the joystick to select “Current Time”, then press .
- 2 If it is currently Daylight Saving Time, be sure to set the mode to “ON” first.
- 3 Use the joystick to enter the correct time, then press .
- 4 Press MENU to exit the menu screen.

To set the Timer

Before setting the timer, be sure to set your LCD projection TV’s clock to the current time and Daylight Saving Mode.

- 1 Move the joystick to “Timer 1” or “Timer 2”, then press .
- 2 Use the joystick to enter your day, time and channel preferences, then press  to select each one.
- 3 Press MENU to exit the menu screen.

To reset the Clock or Timers

- Press RESET on the remote control after selecting that option in the Timer menu.

Selecting Timer Options





The Timer menu includes the following options:

Option	Description
Timer 1	Program
Timer 2	Program
	OFF
Current Time	Set the current time.
Daylight Saving	ON
	OFF



Using the Setup Menu

To select the Setup Menu

- 1 Press MENU.
- 2 Move the joystick to the Setup icon  and press .
- 3 Use the joystick to scroll through the features.
- 4 Press  to select a feature. That feature's options appear.
- 5 Use the joystick to scroll through the options.
- 6 Press  to select the desired option.
- 7 Press MENU to exit the menu screen.

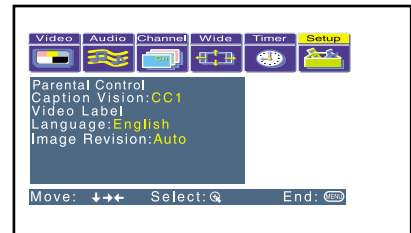



Selecting Setup Options

The Setup menu includes the following options:

<i>Option</i>	<i>Description</i>
Parental Control	Allows you to set up the LCD projection TV to block programs according to their content and rating levels. For details about setting, see “Using the Parent Menu” on page 69.
Caption Vision	Allows you to select from three closed caption modes (for programs that are broadcast with closed captioning).
OFF	Turns off Caption Vision.
CC1, CC2, CC3, CC4	Displays a printed version of the dialog or sound effects of a program. (Should be set to CC1 for most programs.)
TEXT1, TEXT2, TEXT3, TEXT4	Displays network/station information presented using either half or the whole screen (if available). For closed captioning, set to CC1.
XDS (<i>Extended Data Service</i>)	Displays a network name, program name, program length, and time of the show if the broadcaster offers this service.

(Continued)

<i>Option</i>	<i>Description</i>
Video Label	<p>Allows you to label the audio/video components you connected to the LCD projection TV so you can identify them when using TV/VIDEO. When in the Setup menu's Video Label feature, use the joystick to highlight an input to label, then press  to select it. Use the joystick to scroll through the labels. Press  to select the component you connected to each of the input jacks on the back of your LCD projection TV. Select "Skip" if you do not have a component connected to a particular set of input jacks.</p>
VIDEO 1/2/3/4	VHS, 8mm, Beta, LD, Game, SAT, DVD, Web, Receiver, DTV, Skip
VIDEO 5/6	DVD, DTV, HD, Skip
<p>If you select "Skip," your LCD projection TV skips this connection when you press TV/VIDEO.</p>	
<p> When you select "Receiver" on Video Label, your LCD projection TV's input is fixed (for VIDEO 1 only).</p>	
Language	<p>Select to display all on-screen menus in your language of choice: English, Español, Français.</p>
Image Revision	<p>The factory setting is Auto and your LCD projection TV automatically adjusts the doubled images, ghosts, or merged colors. If the "Auto" setting does not take effect, use the joystick to select the value from 0 to 3 with which the symptoms mentioned above are most improved.</p>



Using the Parent Menu

The Parent menu allows you to set up the LCD projection TV to block programs according to their content and rating levels.

These ratings are assigned by a federal rating board. Not all programs are rated. Using the Parental Lock blocks programs with a specific rating, but it does not block an entire channel.

 Scrolling Channel Index will not function when Parental Lock is activated.

To select the rating

- 1 Press MENU.
- 2 Move the joystick to the Setup icon  and press .

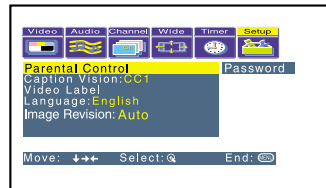

- 3 Make sure that “Parental Control” is selected, and press .

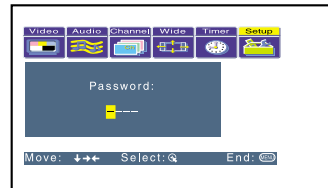

- 4 Use the 0-9 buttons on the remote control to enter your four-digit password.
- 5 Confirm your password by entering it again. Your password is stored and the Parent menu options appear.

 You need the password entered here for any future access into the Parent menu. If you lose your password, see “Lost password” on page 83.

 If you want to change the password, see page 71.

- 6 Make sure that “Country” is selected, and press .

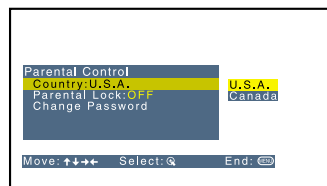

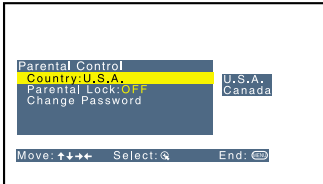

(Continued)

- 7 Move the joystick up or down to select U.S.A. or Canada according to the country you reside in, and press .

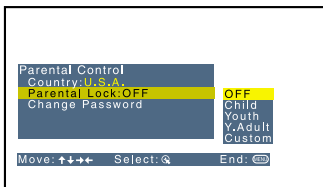

- 8 Move the joystick down to select "Parental Lock", and press .



- 9 Move the joystick up or down to select a desired rating, and press .

If you select Child, Youth, Young Adult or Custom, the Parental Control is activated automatically.

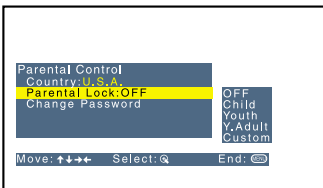

If you want to select the ratings from Custom, see "Using Custom Rating Options" on page 72.

- 10 Press MENU to exit the menu screen.

 If you are not familiar with the Parental Guideline rating system, you should select Child, Youth, or Young Adult to help simplify the rating selection. To set more restrictive ratings, select Custom.

 For descriptions of Child, Youth, and Young Adult ratings, see pages 75 and 76.

The Parent menu includes the following options.

Option	Description	
Parental Lock	OFF	Parental lock is off. No programs are blocked from viewing.
<i>Turn ratings on/off and select a rating system</i>	Child	Maximum ratings permitted are: <input type="checkbox"/> US: TV-Y, TV-G, G <input type="checkbox"/> Canada: TV-Y, C, G
	Youth	Maximum ratings permitted are: <input type="checkbox"/> US: TV-PG, PG <input type="checkbox"/> Canada: TV-PG, PG, 8 ans+
	Young Adult	Maximum ratings permitted are: <input type="checkbox"/> US: TV-14, PG-13 <input type="checkbox"/> Canada: TV-14, 14+, 13 ans+
	Custom	Select to set ratings manually. <input type="checkbox"/> US: See page 75 for details. <input type="checkbox"/> Canada: See page 76 for details.
Change Password	For changing your password. (see below)	

To deactivate the Parental Control feature

- Set Parental Lock to OFF when in the Parent menu.

To change the password

- 1 Select Change Password option when in the Parent menu using the joystick, and press .
- 2 Enter a new four-digit password using the 0-9 buttons.
- 3 Confirm the new password by entering it again.
- 4 Press MENU to exit the menu screen.

Viewing Blocked Programs

You can view a blocked program by entering the password.

- 1 Press ENTER when tuned to a blocked program.
- 2 Enter your password using the 0-9 buttons.

Parental Control will be canceled temporarily until you turn your LCD projection TV off.

Using Custom Rating Options

If you want to select the ratings to be blocked from Custom, follow the procedure below.

- 1 Perform the steps 1 to 8 in “To select the rating” on page 69 to display the Parental Lock options.
- 2 Move the joystick up or down to select “Custom,” and press .

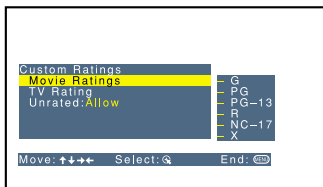

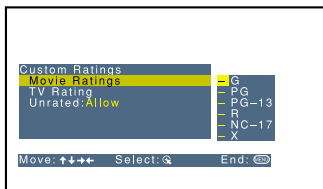

- 3 Make sure that “Movie Ratings” is selected, and press .

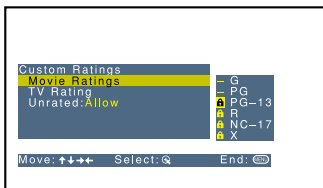

- 4 Move the joystick up or down to select the rating to be blocked, and press .

The  indicator automatically appears beside the selected rating and all “higher” ratings, indicating that the programs that match the ratings will be blocked.



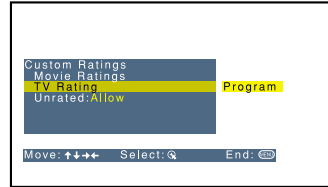

To unblock a rating, select it by moving the joystick up or down, then press . The indicator  changes into “-” and all “lower” ratings are unblocked.

- 5 Move the joystick left, then down, to select “TV Rating” or “Program,” and press .



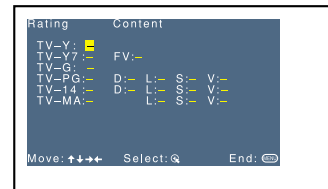

- 6 The “TV Rating” setting menu appears.

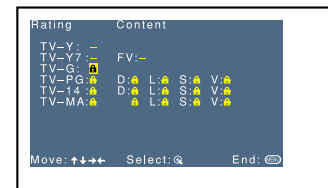

- 7 Move the joystick up or down to select the rating to be blocked, and press .

The  indicator automatically appears beside the selected rating and all “higher” ratings, indicating that the programs that match the ratings will be blocked.



To unblock a rating, select it by moving the joystick up or down, then press . The indicator  changes into “-” and all “lower” ratings are unblocked.



Some TV ratings have additional content ratings called “extenders.” The extenders are defined as follows: D (sexually suggestive Dialog), FV (Fantasy Violence), L (Coarse Language), S (Sexual situations) and V (Violence). By setting the extenders, you can define additional viewing limits. All of the extenders included in the selected ratings will be blocked. If you wish to allow any of them to be viewed, go to step 8.

(Continued)

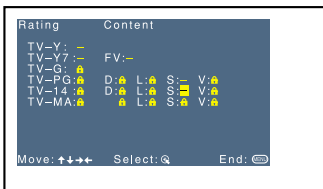
- 8 Move the joystick left or right to select the extender to be viewed, and press .



“-” appears beside the selected extender, indicating that the programs that match the extender can be viewed.

If you press  again,  is displayed to show that the programs that match the extender will be blocked again.

- 9 Repeat step 8 for other extenders.

All programs that match the ratings you select and higher, except for the extenders that were canceled, will be blocked.

- 10 Press MENU to exit the menu screen.

US custom rating options

If you selected U.S.A. as the country of residence on page 70, the Custom Rating Menu includes the following options. (If you selected Canada, see page 76.)

 To ensure maximum blocking capability, the age-based ratings should be blocked.

<i>Option</i>	<i>Description</i>	
Movie Rating	G All children and General Audience.	
	PG Parental Guidance suggested.	
	PG-13 Parental Guidance for children under 13.	
	R Restricted viewing, parental guidance is suggested for children under 17.	
	NC-17 and X No one 17 and under allowed.	
TV Rating	Age-Based Options	
<i>Block programs by their rating, content or both</i>	TV-Y All children.	
	TV-Y7 Directed to older children.	
	TV-G General Audience.	
	TV-PG Parental Guidance suggested.	
	TV-14 Parents Strongly cautioned.	
	TV-MA Mature Audience only.	
	Content-Based Options	
	FV Fantasy Violence.	
	D Suggestive Dialogue.	
	L Strong Language.	
S Sexual situations.		
V Violence.		
Unrated	Block Blocks all programs and movies that are broadcast without a rating.	
	Allow Allows programs and movies that are broadcast without a rating.	
<i>Block programs or movies that are broadcast without a rating</i>	 If you select “Block,” please be aware that the following programs may be blocked: emergency broadcasts, political programs, sports, news, public service announcements, religious programs and weather.	

 The content ratings will increase depending on the level of the age-based rating. For example, a program with a TV-PG V (Violence) rating may contain moderate violence, while a TV-14 V (Violence) rating may contain more intense violence.

(Continued)

Canadian custom rating options

If you selected Canada as the country of residence on page 70, the Custom Rating Menu includes the following options. (If you selected U.S.A., see page 75.)

<i>Option</i>	<i>Description</i>	
English Rating	C	All children.
	C8+	Children 8 years and older.
	G	General programming.
	PG	Parental Guidance.
	14+	Viewers 14 and older.
	18+	Adult programming.
French Rating	G	General programming.
	8 ans+	Not recommended for young children.
	13 ans+	Not recommended for ages under 13.
	16 ans+	Not recommended for ages under 16.
	18 ans+	Programming restricted to adults.
USA Rating	See "TV Rating" on page 75 for details.	

Other Information

Programming the Remote Control

The remote control is preset to operate Sony brand video equipment.

<i>Sony Equipment</i>	<i>Switch Position on Remote Control</i>	<i>Programmable Code Number</i>
Beta, ED Beta VCRs	AV1	303
8 mm VCR	AV2	302
VHS VCR	AV3	301
DVD Player	DVD	751

If you have video equipment other than Sony brand that you want to control with the LCD projection TV's remote control, use the following procedures to program the remote control.

 The equipment must have infrared (IR) remote capability in order to be used with the remote control.

Other Information

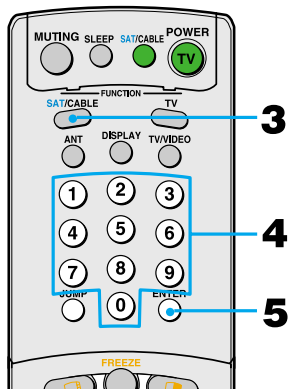
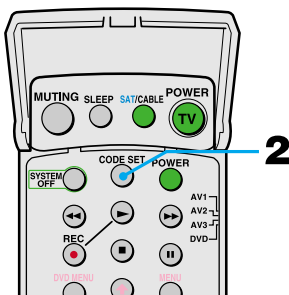

From the “Manufacturer’s Codes” listed on page 79, select the three-digit code number for the manufacturer’s code for your component. If more than one code number is listed, start with the number listed first. Use the code number to complete the following procedure.

To program a cable box or a satellite receiver

- 1 Open the panel of the remote control.
- 2 Press CODE SET inside the panel.
- 3 Close the panel and press SAT/CABLE (FUNCTION).
- 4 Enter the three-digit manufacturer’s code number using the 0-9 buttons.
- 5 Press ENTER.
- 6 To check if the code number works, aim the LCD projection TV’s remote control at the component and press the green POWER button that corresponds with that component. If it responds, the programming is completed. If not, try using the other codes listed for that manufacturer.

(Continued)

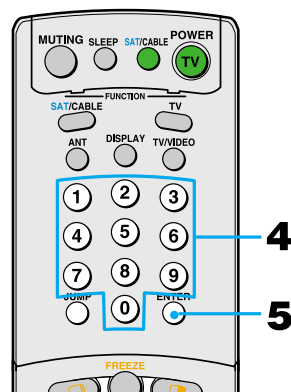
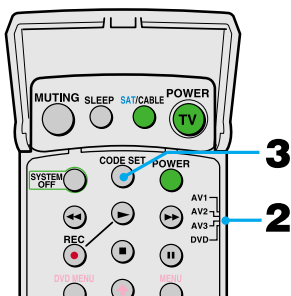

To program video equipment

- 1 Open the panel of the remote control.
- 2 Move the slide switch to the desired component type.
- 3 Press CODE SET inside the panel.
 -  You must perform step 4 within 10 seconds of step 3, or you must start again from step 3.
- 4 Close the panel and enter the three-digit manufacturer's code number using the 0-9 buttons.
- 5 Press ENTER.
- 6 To check if the code number works, aim the LCD projection TV's remote control at the component, open the panel, and press the green POWER button. If it responds, the programming is completed. If not, try using the other codes listed for that manufacturer.

Tips

- ❑ If more than one code number is listed, try entering them one by one until you come to the correct code for your component.
- ❑ If you enter a new code number, the code number you previously entered at that setting is erased.
- ❑ In some rare cases, you may not be able to operate your component with the Sony remote control. In this case, use the component's own remote control unit.

Manufacturer's Codes**VCRs**

<i>Manufacturer</i>	<i>Code</i>
Sony	301
Admiral (M. Ward)	327
Aiwa	338, 344
Audio Dynamic	314, 337
Broksonic	319, 317
Canon	309, 308
Citizen	332
Craig	302, 332
Criterion	315
Curtis Mathes	304, 338, 309
Daewoo	341, 312, 309
DBX	314, 336, 337
Dimensia	304
Emerson	319, 320, 316, 317, 318, 341
Fisher	330, 335
Funai	338
General Electric	329, 304, 309
Go Video	322, 339, 340
Goldstar	332
Hitachi	306, 304, 305, 338
Instant Replay	309, 308
JC Penney	309, 305, 304, 330, 314, 336, 337
JVC	314, 336, 337, 345, 346, 347
Kenwood	314, 336, 332, 337
LXI (Sears)	332, 305, 330, 335, 338
Magnavox	308, 309, 310
Marantz	314, 336, 337
Marta	332
Memorex	309, 335

<i>Manufacturer</i>	<i>Code</i>
Minolta	305, 304
Mitsubishi/ MGA	323, 324, 325, 326
Multitech	325, 338, 321
NEC	314, 336, 337
Olympic	309, 308
Optimus	327
Panasonic	308, 309, 306, 307
Pentax	305, 304
Philco	308, 309
Philips	308, 309, 310
Pioneer	308
Quasar	308, 309, 306
RCA/ PROSCAN	304, 305, 308, 309, 311, 312, 313, 310, 329
Realistic	309, 330, 328, 335, 324, 338
Sansui	314
Samsung	322, 313, 321
Sanyo	330, 335
Scott	312, 313, 321, 335, 323, 324, 325, 326
Sharp	327, 328
Shintom	315
Signature 2000 (M. Ward)	338, 327
SV2000	338
Sylvania	308, 309, 338, 310
Symphonic	338
Tashiro	332
Tatung	314, 336, 337
Teac	314, 336, 338, 337
Technics	309, 308
Toshiba	312, 311

<i>Manufacturer</i>	<i>Code</i>
Wards	327, 328, 335, 331, 332
Yamaha	314, 330, 336, 337
Zenith	331

DVD Players

<i>Manufacturer</i>	<i>Code</i>
Sony	751
Panasonic	753
Pioneer	752
RCA	755
Toshiba	754

Cable Boxes

<i>Manufacturer</i>	<i>Code</i>
Hamlin/Regal	222, 223, 224, 225, 226
Jerrold/G. I.	201, 202, 203, 204, 205, 206, 207, 208, 218
Oak	227, 228, 229
Panasonic	219, 220, 221
Pioneer	214, 215
Scientific Atlanta	209, 210, 211
Tocom	216, 217
Zenith	212, 213

Satellite Receivers

<i>Manufacturer</i>	<i>Code</i>
Sony	801
General Electric	802
Hitachi	805
Hughes	804
Panasonic	803
RCA/ PROSCAN	802, 808
Toshiba	806, 807

Operating Other Components with Your LCD Projection TV Remote Control

Operating a VCR

Open the panel and move the slide switch to the AV input you coded for this device.

<i>To Do This ...</i>	<i>Press</i>
Turn on/off	green POWER button (inside the panel)
Change channels	CH +/-
Record	▶ and REC simultaneously
Play	▶
Stop	■
Fast forward	▶▶
Rewind the tape	◀◀
Pause	(press again to resume normal playback)
Search the picture forward or backward	▶▶ or ◀◀ during playback (release to resume normal playback)
Change input mode	Slide switch

Operating a DVD Player

Open the panel and move the slide switch to the DVD input you coded for this device.

<i>To Do This ...</i>	<i>Press</i>
Turn on/off	green POWER button (inside the panel)
Play	▶
Stop	■
Pause	(press again to resume normal playback)
Step through different tracks of an audio disc	▶▶ to step forward or ◀◀ to step backward
Step through different chapters of a video disc	CH+ to step forward or CH- to step backward
Display the DVD menu	DVD MENU
Display the menu (Setup)	MENU
Operate the DVD menu	↑, ↓, ←, →, ENTER

Operating a Cable Box

<i>To Do This ...</i>	<i>Press</i>
Turn on/off	SAT/CABLE (POWER)
Select Cable Box	SAT/CABLE (FUNCTION)
Select a channel	0-9 buttons, ENTER
Change channels	CH +/-
Back to previous channel	JUMP

Operating a Satellite Receiver

<i>To Do This ...</i>	<i>Press</i>
Turn on/off	SAT/CABLE (POWER)
Select Satellite Receiver	SAT/CABLE (FUNCTION)
Select a channel	0-9 buttons, ENTER
Change channels	CH +/-
Back to previous channel	JUMP
Display channel number	DISPLAY
Display DBS guide	GUIDE
Display DBS menu	MENU
Move highlight (cursor)	Joystick or arrows
Select item	

Troubleshooting

If, after reading these operating instructions, you have additional questions related to the use of your Sony television, please call our Customer Information Services Center at 1-800-222-SONY (7669) (U.S. residents only) or (416) 499-SONY (7669) (Canadian residents only).

Problem	Possible Remedies
No picture (screen not lit), no sound	<ul style="list-style-type: none"> <input type="checkbox"/> Make sure the LCD projection TV's power cord is connected securely to the wall outlet. <input type="checkbox"/> Push the power button on the front of the LCD projection TV. <input type="checkbox"/> Check to see if the TV/VIDEO setting is correct: when watching TV, set to TV, and when watching connected equipment, set to VIDEO 1, 2, 3, 4, 5 or 6. <input type="checkbox"/> Try another channel. It could be station trouble. <input type="checkbox"/> The Parental Control feature is activated (see "Using the Parent Menu" on page 69). <input type="checkbox"/> If your LCD projection TV does not turn on, and a red light keeps flashing, your LCD projection TV may need service. Call your local Sony Service Center.
Remote control does not operate	<ul style="list-style-type: none"> <input type="checkbox"/> Batteries could be weak. Replace the batteries. <input type="checkbox"/> Press TV (FUNCTION) when operating your LCD projection TV. <input type="checkbox"/> Make sure the LCD projection TV's power cord is connected securely to the wall outlet. <input type="checkbox"/> Locate the LCD projection TV at least 3-4 feet away from fluorescent lights. <input type="checkbox"/> Check the orientation of the batteries.
Dark, poor or no picture (screen lit), good sound	<ul style="list-style-type: none"> <input type="checkbox"/> Adjust the Picture setting in the Video menu (see page 58). <input type="checkbox"/> Adjust the Brightness setting in the Video menu (see page 58). <input type="checkbox"/> Check antenna/cable connections. It is strongly recommended to connect the antenna using a 75-ohm coaxial cable to get optimum picture quality. A 300-ohm twin lead cable can be easily affected by radio noise and the like, resulting in signal deterioration. If you use a 300-ohm twin lead cable, keep it away as far as possible from the LCD projection TV. Do not use an indoor antenna because it is especially susceptible to radio noise (see page 25).
Good picture, no sound	<ul style="list-style-type: none"> <input type="checkbox"/> Press MUTING so that "MUTING" disappears from the screen (see page 43). <input type="checkbox"/> Make sure Speaker is set to ON in the Audio menu (see page 61). <input type="checkbox"/> Check the MTS setting in the Audio menu (see "MTS" on page 61).
Cannot receive digital channels (when a DTV receiver is connected)	<ul style="list-style-type: none"> <input type="checkbox"/> Check the connections between the DTV receiver and the LCD projection TV (see page 38). <input type="checkbox"/> Check your local listings to find out if you can receive digital broadcasts in your area.
Cannot receive upper channels (UHF) when using an antenna	<ul style="list-style-type: none"> <input type="checkbox"/> Change Cable to OFF (see page 62). <input type="checkbox"/> Use Auto Program in the Channel menu to add receivable channels that are not presently in TV memory (see page 63).
No color	<ul style="list-style-type: none"> <input type="checkbox"/> Adjust the Color settings in the Video menu (see page 58).
Only snow and noise appear on the screen	<ul style="list-style-type: none"> <input type="checkbox"/> Check the Cable setting in the Channel menu (see "Cable" on page 62). <input type="checkbox"/> Check the antenna/cable connections. <input type="checkbox"/> Make sure the channel is broadcasting programs. <input type="checkbox"/> Press ANT to change the input mode (see page 46).

Problem	Possible Remedies
Dotted lines or stripes	<ul style="list-style-type: none"> <input type="checkbox"/> Adjust the antenna. <input type="checkbox"/> Move the LCD projection TV away from noise sources such as cars, neon signs, or hair-dryers.
LCD projection TV is fixed to one channel	<ul style="list-style-type: none"> <input type="checkbox"/> Use Auto Program in the Channel menu to add receivable channels that are not presently in TV memory (see page 63). <input type="checkbox"/> Check your Channel Fix settings (see page 63).
Double images, ghosts, or merged colors	<ul style="list-style-type: none"> <input type="checkbox"/> Use a highly directional outdoor antenna or a cable (when the problem is caused by reflections from nearby mountains or tall buildings). <input type="checkbox"/> Set the Image Revision to an appropriate value. The default setting is Auto. If ghosts, doubled images, or merged colors appear with Auto, select the best value from 0 to 3 (see page 68).
Cannot operate menu	<ul style="list-style-type: none"> <input type="checkbox"/> If the item you want to choose appears in gray, you cannot select it. <input type="checkbox"/> Turn the LCD projection TV's power off and on again.
Cannot receive any channels when using cable TV	<ul style="list-style-type: none"> <input type="checkbox"/> Use Auto Program in the Channel menu to add receivable channels that are not presently in TV memory (see page 63). <input type="checkbox"/> Check your cable settings. <input type="checkbox"/> Make sure Cable is set to ON in the Channel menu (see page 62).
Cannot gain enough volume when using a cable box	<ul style="list-style-type: none"> <input type="checkbox"/> Increase the volume of the cable box using the cable box's remote control. Then press TV (FUNCTION) and adjust the LCD projection TV's volume.
Channel Index does not display all available channels	<ul style="list-style-type: none"> <input type="checkbox"/> Make sure Cable is set to ON in the Channel menu (see "Cable" on page 62). <input type="checkbox"/> Use Auto Program in the Channel menu to add receivable TV channels that are not presently in TV memory (see page 63).
Cannot receive channels Unable to select a channel	<ul style="list-style-type: none"> <input type="checkbox"/> Use Auto Program in the Channel menu to add receivable TV channels that are not presently in TV memory (see page 63).
Lost password	<ul style="list-style-type: none"> <input type="checkbox"/> In the password screen (see page 69), enter the following master password: 4357. The master password clears your previous password; it cannot be used to temporarily unblock channels.
Cannot change channels with the remote control	<ul style="list-style-type: none"> <input type="checkbox"/> Be sure you have not inadvertently switched your LCD projection TV from channel 3 or 4 setting if you are using another device to change channels. <input type="checkbox"/> If you are using another device to control channels, be sure the "function" button for that device has been pressed, or the slide switch is set correctly. For example, if you are using your cable to control channels, be sure to press SAT/CABLE.
Cannot cycle through the other video equipment connected to the LCD projection TV	<ul style="list-style-type: none"> <input type="checkbox"/> Be sure the Video Label feature has not been set to Skip (see page 68).
There is a black box on the screen	<ul style="list-style-type: none"> <input type="checkbox"/> You have selected a text option in the Setup menu and no text is available. (see page 67 to reset Setup selections) To turn this feature off, select OFF in the Caption Vision option. If you were trying to get closed captioning, select CC1 instead of Text 1-4.

(Continued)

Other Information

Problem	Possible Remedies
There is no twin picture or it is just static	<ul style="list-style-type: none"><input type="checkbox"/> Be sure your twin picture is set to a video source/channel that has a program airing.<input type="checkbox"/> You may be tuned to a video input with nothing connected to it. Try cycling through your video inputs using TV/VIDEO.<input type="checkbox"/> Twin View is not set to receive a signal from the AUX input. If you have connected a VCR, DVD player or satellite receiver to the AUX input on the LCD projection TV, it will not show in the second picture.
You get the same program in the window picture as in the main picture	<ul style="list-style-type: none"><input type="checkbox"/> Both may be set to the same channel. Try changing channels in either the main picture or the window picture.<input type="checkbox"/> You may be running all your channels through a cable box. The cable box will only unscramble one signal at a time, so you cannot use the Twin View feature. If possible, run a direct cable to your LCD projection TV's VHF/UHF input (this will only work if your cable system provides an unscrambled signal.)
You cannot get anything but TV channels in your second picture	<ul style="list-style-type: none"><input type="checkbox"/> Be sure the video label has not been set to skip your video inputs. See the Setup menu on page 68.
Favorite Channel does not display your choices	<ul style="list-style-type: none"><input type="checkbox"/> Verify that Favorite Channel is set to Manual in the Channel menu (see "Favorite Channel" on page 62).
Some video sources do not appear when you press TV/VIDEO	<ul style="list-style-type: none"><input type="checkbox"/> Ensure that Video Label is not set to "Skip" (see "Video Label" on page 68).

What Flashing of the Indicators on the Front of the Monitor Means

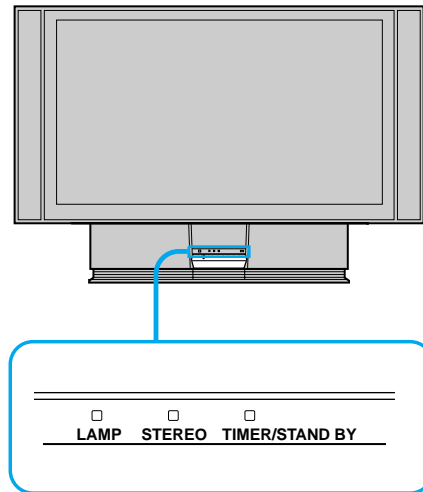

The TIMER/STAND BY (red) and/or LAMP (red) indicators indicate the conditions of the LCD projection TV and warnings by lighting or flashing, as follows.

The TIMER/STAND BY indicator flashes.

- ❑ The lamp for the light source is ready to turn on.

The TIMER/STAND BY indicator flashes three times.

- ❑ The lamp cover is not attached securely. When you correct, the TIMER/STAND BY indicator goes out and the LCD projection TV enters the standby mode (see page 13).

The LAMP indicator flashes.

- ❑ The lamp for the light source burns out.
Replace it with new one (see page 13).

If the LCD projection TV is not recovered after correcting the problems, contact with qualified Sony personnel.

Specifications

Projection System	3 LCD Panels, 1 lens projection system	
LCD Panel	1.35 inch TFT LCD panel Approx. 3.15 million dots (1,049,088 pixels)	
Projection Lens	High Performance, large diameter hybrid lens F2.4	
Antenna	75 ohm external terminal for VHF/UHF	
Lamp	UHP lamp, 100W XL-2000U	
Television System	NTSC, American TV Standard	
Screen Size (measured diagonally)	60 inches	
Channel Coverage		
VHF	2-13	
UHF	14-69	
CATV	1-125	
Power Requirements	120V, 60 Hz	
Number of Inputs/Outputs		
Video (IN)	4	1 Vp-p, 75 ohms unbalanced, sync negative
S Video (IN)	3	Y: 1 Vp-p, 75 ohms unbalanced, sync negative C: 0.286 Vp-p (Burst signal), 75 ohms
Audio (IN)	6	500 mVrms (100% modulation) Impedance: 47 kilohms
AUDIO (VAR/FIX)	1	500 mVrms at the maximum volume setting (Variable) 500 mVrms (Fixed) Impedance (output): 2 kilohms
TV Out	1	Video: 1 Vp-p 75 ohms unbalanced, Sync negative Audio: 500 mVrms (100% modulation) Impedance (output): 1 kilohms
CONTROL S (IN/OUT)	1	minijacks
Component Video Input	2 (Y, P _B , P _R)	Y: 1.0 Vp-p, 75 ohms unbalanced, sync negative P _B : 0.7 Vp-p, 75 ohms P _R : 0.7 Vp-p, 75 ohms
RF Inputs	2	
Converter	1	
Speaker Output	15 W × 2	
Dimensions (W × H × D)	1,618 × 1,103 × 542 mm (63 ³ / ₄ × 43 ¹ / ₂ × 21 ³ / ₈ inches)	
Mass	63 kg (138 lb 14 oz)	
Power Consumption		
In Use	220 W	
In Standby	Under 1 W	

Supplied Accessories

Remote Control	RM-Y910
AA Batteries	2 supplied for remote control
Cleaning Cloth	1
Hex key wrench	1
Brackets with screws	2

Optional Accessories

TV Stand	SU-60DX
Lamp	XL-2000U
AV Cable	VMC-810/820/830 HG
Audio Cable	RKC-515HG
Control S Cable	RK-G69HG
Component Video Cable	VMC-10/30 HG
AV Receiver	STR-V555ES or equivalent

Design and specifications are subject to change without notice.

Index

- A**
 - Activating a Twin View screen **50**
 - Adding channels to the channel list **63**
 - Adjusting audio, Steady Sound **60**
 - ANT button **43**
 - Antenna, connecting **25**
 - Audio menu **57, 60**
 - Audio receiver, connecting **35**
 - Audio/Video cable **21**
 - Auto Program (channel setup) **42, 63**
 - Auto Setup **42, 63**
 - AV receiver, connecting to TV OUT **24**
- B**
 - Balance, adjusting **60**
 - Bass, adjusting **60**
 - Batteries, inserting in remote **17**
 - Bilingual audio **61**
 - Brightness, adjusting **58**
- C**
 - Cable
 - connecting **25–28**
 - setting ON/OFF **63**
 - with VCR, connecting **29**
 - Cable box
 - connecting with VCR **30**
 - using with TV remote control **81**
 - Camcorder, connecting **39**
 - Caption Vision **67**
 - CATV. See Cable.
 - Channel list, adding channels **63**
 - Channel menu **57, 62**
 - Channel Skip/Add **63**
 - Channels
 - Auto Program **63**
 - creating labels **63**
 - setting up **42**
 - CineMotion **44**
 - CINEMOTION button **44**
 - Cleaning Cloth **12**
 - Closed caption modes **67**
 - CODE SET button **45**
 - Color temperature, adjusting **59**
 - Color, adjusting **58**
- 88**
- Connecting
 - Audio receiver **35**
 - AV receiver **40**
 - Cable box **26–28, 30–31**
 - Cable or antenna **25**
 - Camcorder **39**
 - Digital TV Receiver **38**
 - DVD player **36, 37**
 - Satellite receiver **33, 34**
 - VCR **30–32, 34**
- Connector Types **21**
- Contents of box **17**
- CONTROL S **41**
- D**
 - Daylight saving **66**
 - Digital Reality Creation **59**
 - Digital TV
 - connecting **38**
 - watching **48**
 - Digital TV program **48**
 - Digital TV receiver, connecting **38**
 - DISPLAY button **43**
 - Display, turning off **43**
 - DRC (Digital Reality Creation) Mode, described **9**
 - DVD MENU button **45**
 - DVD player
 - using with TV remote control **80**
 - with A/V connectors, connecting **37**
 - with component video connectors, connecting **36**
- E**
 - Enlarging pictures, in Twin View **52**
 - Extended Data Service **67**
- F**
 - Favorite Channel
 - auto **62**
 - described **9**
 - manual **62**
 - setting up **62**
 - using **49**
 - FAVORITES button **44**
 - Features **9**
 - FREEZE button **43**
 - Freeze, using **46, 53**

Front Panel Controls **22**
FUNCTION buttons (WHITE) **44**

H

Hookups **25**
Hue, adjusting **58**

I

Image Revision **68**
Inputs, labeling **68**
Installation of the projection TV **25–41**

J

JUMP button **43**
Jump, using **46**

L

Label
 channels **63**
 video inputs **68**
Lamp, replacing **13–16**

M

MENU button **44**
MENU button (inside panel) **45**
Menus

 Audio **57, 60**
 Channel **57, 62**
 Setup **57, 67**
 Timer **57, 66**
 Video **57, 58**
 Wide **57, 64**

MODE

 Mild **47**
 Movie **47**
 Standard **47**
 Vivid **47**

MTS/SAP button **45**
MTS/SAP, using **47**
Muting, using **46**

P

Parental control, described **9**
Password, changing **71**
PIC MODE button **43**
Picture contrast, adjusting **58**
Picture size, adjusting in Twin View **52**
POWER button **45**
POWER buttons (GREEN) **44**

Presetting channels **42**
Problems, troubleshooting **82–85**

R

Ratings
 setting **69–71**
 viewing blocked programs **71**
Rear panel controls and connections **23, 24**
Remote control
 buttons inside panel **45**
 Function of buttons **46**
 inserting batteries **17**
 programming **77–79**
Remote control, operating other components with
 Cable box **81**
 DVD player **80**
 Satellite receiver **81**
 VCR **80**
Removing channels from the channel list **63**
RESET button **44**
Resetting
 Audio options **60**
 Timer options **66**
 Video options **58**

S

S Video cable **21**
SAT/CABLE function button **44**
SAT/CABLE power button **44**
Satellite receiver
 connecting **33**
 using with TV remote control **81**
Setting up channels **42**
Setup menu **57, 67**
Sharpness, adjusting **58**
SLEEP button **43**
Sleep, using **46**
Specifications **86–87**
Steady Sound
 adjusting **60**
Surround sound **60**
SYSTEM OFF button **45**

T

Time
 set current **66**
 set daylight saving **66**
Timer menu **57, 66**
Timer setting **66**

(Continued)

Treble, adjusting **60**
Troubleshooting **82–85**
TV function button **44**
TV power button **44**
TV/VIDEO button **44**
Twin View™
 activating a picture **50**
 described **9**
 using **50**

V

VCR
 using with TV remote control **80**
 with cable box, connecting **30**
 with cable, connecting **29**
 with satellite receiver, connecting **34**
Video inputs, labeling **68**
Video menu **57, 58**
Video Modes, selecting **58**
Viewing area, recommended **20**
VOL +/- button **43**

W

Wide menu **57, 64**

Z

Zoom feature, with Twin View **52**

If, after reading this instruction manual, you have additional questions related to the use of your Sony projection TV, please call one of the following numbers (English only).

Customers in the continental United States

contact the Direct Response Center at:

1-800-222-SONY (7669)

Customers in Canada contact the

Customer Relations Center at:

(416) 499-SONY (7669)

<http://www.sony.net/>

Printed in Japan